



NEBS™ Requirements: Physical Protection

(A Module of LSSGR, FR-64; TSGR, FR-440; and NEBSFR, FR-2063)

Telcordia Technologies Generic Requirements
GR-63-CORE
Issue 3, March 2006

Comments Requested (See Preface)

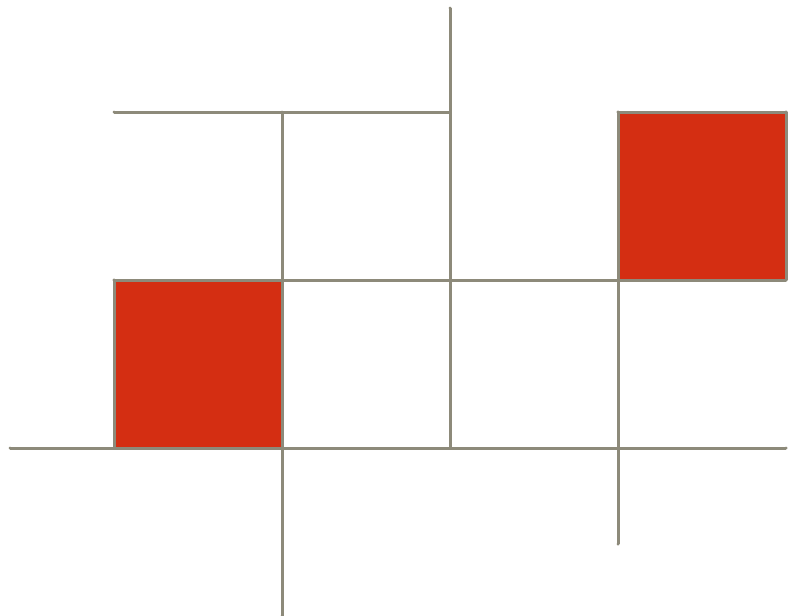

NEBS™ Requirements: Physical Protection

Prepared for Telcordia Technologies, Inc. by: Network Infrastructure and Operations.

This document replaces: GR-63-CORE, Issue 2, April 2002.

This document is a module of LSSGR, FR-64; TSGR, FR-440; and NEBSFR, FR-2063.

Where major additions or technical changes have occurred in Issue 3, the location of the change is marked by a vertical bar (|) in the outer margin next to the change.

Technical contact:

Richard Kluge, Director
Telcordia — GR-63-CORE
One Telcordia Drive, Room 4D-660
Piscataway, NJ 08854-4182

Phone: + 1.732.699.5490
FAX: + 1.732.336.3235
E-Mail: rkluge@telcordia.com

To obtain copies of this document, contact your company's document coordinator or your Telcordia account manager, or call 1.866.672.6997 (USA) or + 1.732.699.6700 (Worldwide), or visit our Web site at <http://telecom-info.telcordia.com>.

Copyright © 1995, 2002, 2006 Telcordia Technologies, Inc. All rights reserved.

Trademark Acknowledgments

Telcordia is a registered trademark and NEBS is a trademark of Telcordia Technologies, Inc. All other brand or product names are trademarks of their respective companies or organizations.

Generic Requirements Notice of Disclaimer

This Generic Requirements document (GR) is published by Telcordia Technologies to inform the industry of the Telcordia view of proposed generic requirements for *NEBS™ Requirements: Physical Protection*. The generic requirements contained herein are subject to review and change, and superseding generic requirements regarding this subject may differ from those in this document. Telcordia reserves the right to revise this document for any reason (consistent with applicable provisions of the Telecommunications Act of 1996 and applicable FCC rules).

TELCORDIA AND THE OTHER PARTICIPANTS IDENTIFIED IN THE PREFACE MAKE NO REPRESENTATION OR WARRANTY, EXPRESSED OR IMPLIED, WITH RESPECT TO THE SUFFICIENCY, ACCURACY, OR UTILITY OF ANY INFORMATION OR OPINION CONTAINED HEREIN.

TELCORDIA AND THE OTHER PARTICIPANTS EXPRESSLY ADVISE THAT ANY USE OF OR RELIANCE UPON SAID INFORMATION OR OPINION IS AT THE RISK OF THE USER AND THAT NEITHER TELCORDIA NOR ANY OTHER PARTICIPANT SHALL BE LIABLE FOR ANY DAMAGE OR INJURY INCURRED BY ANY PERSON ARISING OUT OF THE SUFFICIENCY, ACCURACY, OR UTILITY OF ANY INFORMATION OR OPINION CONTAINED HEREIN.

LOCAL CONDITIONS MAY GIVE RISE TO A NEED FOR ADDITIONAL PROFESSIONAL INVESTIGATIONS, MODIFICATIONS, OR SAFEGUARDS TO MEET SITE, EQUIPMENT, ENVIRONMENTAL SAFETY OR COMPANY-SPECIFIC REQUIREMENTS. IN NO EVENT IS THIS INFORMATION INTENDED TO REPLACE FEDERAL, STATE, LOCAL, OR OTHER APPLICABLE CODES, LAWS, OR REGULATIONS. SPECIFIC APPLICATIONS WILL CONTAIN VARIABLES UNKNOWN TO OR BEYOND THE CONTROL OF TELCORDIA. AS A RESULT, TELCORDIA CANNOT WARRANT THAT THE APPLICATION OF THIS INFORMATION WILL PRODUCE THE TECHNICAL RESULT OR SAFETY ORIGINALLY INTENDED.

This GR is not to be construed as a suggestion to anyone to modify or change any product or service, nor does this GR represent any commitment by anyone, including but not limited to Telcordia and the other participants in the development of this Telcordia GR, to purchase, manufacture, or sell any product with the described characteristics.

Readers are specifically advised that any entity may have needs, specifications, or requirements different from the generic descriptions herein. Therefore, anyone wishing to know any entity's needs, specifications, or requirements should communicate directly with that entity.

Nothing contained herein shall be construed as conferring by implication, estoppel, or otherwise any license or right under any patent, whether or not the use of any information herein necessarily employs an invention of any existing or later issued patent.

TELCORDIA DOES NOT HEREBY RECOMMEND, APPROVE, CERTIFY, WARRANT, GUARANTEE, OR ENDORSE ANY PRODUCTS, PROCESSES, OR SERVICES, AND NOTHING CONTAINED HEREIN IS INTENDED OR SHOULD BE UNDERSTOOD AS ANY SUCH RECOMMENDATION, APPROVAL, CERTIFICATION, WARRANTY, GUARANTY, OR ENDORSEMENT TO ANYONE.

For general information about this or any other Telcordia documents, please contact:

Telcordia Customer Service
One Telcordia Drive, Room 1B-180
Piscataway, NJ 08854-4182
1.866.672.6997 (USA)
+ 1.732.699.6700 (Worldwide)
+ 1.732.336.2226 (FAX)
e-mail: document-info@telcordia.com
web site: <http://telecom-info.telcordia.com>

Table of Contents

1 Introduction

1.1 Purpose and Scope	1-1
1.2 Service Provider Role	1-1
1.3 Equipment Manufacturer Role	1-2
1.4 Application Guidelines	1-3
1.4.1 COs and Similar Facilities	1-3
1.4.2 Commercial Buildings	1-3
1.4.3 Non-Environmentally Controlled Locations	1-3
1.4.4 Other Locations	1-3
1.5 Reasons for GR-63-CORE, Issue 3	1-4
1.6 Structure and Use of This Document	1-4
1.7 Related Documents	1-5
1.8 Requirements Terminology	1-5
1.9 Requirement Labeling Conventions	1-6
1.9.1 Numbering of Requirement and Related Objects	1-6
1.9.2 Requirement, Conditional Requirement, and Objective Identification	1-7

2 Spatial Requirements

2.1 General Requirements	2-1
2.1.1 Equipment Frame Floor Plans	2-3
2.1.2 NEBS Data (ND)	2-3
2.2 Equipment Frames	2-6
2.2.1 Vertical Space Allocation in an Equipment Frame Area	2-6
2.2.2 Equipment Frame Dimensions	2-7
2.2.2.1 Equipment Frame Dimensions - Open Style Racks	2-9
2.2.2.2 Equipment Frame Dimensions - Other Rack Styles	2-9
2.2.2.3 Equipment Frame Dimensions - Special Cases	2-10
2.2.2.4 Equipment Frame Cable Management Provisions	2-11
2.2.2.5 Equipment Frame Interface with Cable Rack	2-11
2.2.3 Equipment Frame Lineup Conformity	2-12
2.2.4 Equipment Frame Floor Loading	2-12
2.2.5 AC Convenience Outlets Within Equipment Frames	2-14
2.3 Distributing and Interconnecting Frames	2-14
2.3.1 Distributing Frames (DFs)	2-14
2.3.2 Interconnecting Frames (IFs)	2-15
2.4 DC Power Plant Equipment	2-16
2.4.1 Centralized DC Power Plant Equipment	2-16
2.5 Cable Distribution Systems (CDSs)	2-17
2.5.1 CDS Requirements	2-18
2.5.1.1 General	2-18
2.5.1.2 Overhead Cable Distribution	2-18
2.5.1.3 Cable Distribution Under Raised Floor	2-18
2.5.2 Cable Pathways Over Equipment Frame Areas	2-19
2.5.2.1 Elements of Allocation Plan	2-19
2.5.2.2 System Cable Racks	2-20
2.5.2.3 Via Cable Racks	2-21

- 2.5.2.4 Lights 2–21
- 2.5.3 Cable Pathways Over Distributing Frame (DF) Areas 2–21
- 2.5.4 CDS Floor Load and Support 2–21
- 2.6 Operations Systems (OSs) 2–22
- 2.7 Cable Entrance Facility (CEF) 2–23
 - 2.7.1 CEF Spatial Requirements 2–23
 - 2.7.2 CEF Loading Requirements 2–23
 - 2.7.3 CEF Equipment Temperature and Humidity Requirements 2–23
- 2.8 Summary of Equipment Allocations 2–24

3 NEBS-2000 Framework Criteria

4 Environmental Criteria

- 4.1 Temperature, Humidity, and Altitude Criteria 4–1
 - 4.1.1 Transportation and Storage Environmental Criteria 4–1
 - 4.1.1.1 Low-Temperature Exposure and Thermal Shock 4–2
 - 4.1.1.2 High Relative Humidity Exposure 4–2
 - 4.1.1.3 High-Temperature Exposure and Thermal Shock 4–3
 - 4.1.2 Operating Temperature and Humidity Criteria 4–3
 - 4.1.3 Altitude 4–5
 - 4.1.4 Temperature Margin Evaluation 4–5
 - 4.1.5 Fan Cooled Equipment Criteria 4–6
 - 4.1.6 Heat Dissipation 4–6
 - 4.1.7 Surface Temperature 4–8
 - 4.1.8 Equipment Airflow 4–9
- 4.2 Fire Resistance 4–11
 - 4.2.1 Fire-Resistance Rationale 4–11
 - 4.2.2 Equipment Assembly Fire Tests 4–11
 - 4.2.2.1 Frame-Level Fire-Resistance Criteria 4–12
 - 4.2.2.2 Shelf-Level Fire-Resistance Criteria 4–13
 - 4.2.2.3 Smoke and Self-Extinguishment Criteria 4–14
 - 4.2.3 Use of Fire-Resistant Materials, Components, Wiring, and Cable 4–15
 - 4.2.3.1 Material/Components Fire-Resistance Criteria 4–15
 - 4.2.3.2 Cable Distribution Assemblies 4–17
 - 4.2.4 Smoke Corrosivity 4–18
 - 4.2.4.1 Optical Fiber Cable Trays and Raceways 4–18
- 4.3 Equipment Handling Criteria 4–19
 - 4.3.1 Packaged Equipment Shock Criteria 4–19
 - 4.3.1.1 Category A Containers 4–20
 - 4.3.1.2 Category B Containers 4–20
 - 4.3.2 Unpackaged Equipment Shock Criteria 4–20
- 4.4 Earthquake, Office Vibration, and Transportation Vibration 4–21
 - 4.4.1 Earthquake Environment and Criteria 4–21
 - 4.4.1.1 Earthquake Environment 4–21
 - 4.4.1.2 Physical Performance Criteria 4–23
 - 4.4.1.3 Functional Performance 4–24
 - 4.4.2 Framework and Anchor Criteria 4–24
 - 4.4.3 Wall-Mounted Equipment Anchor Criterion 4–26
 - 4.4.4 Office Vibration Environment and Criteria 4–26
 - 4.4.4.1 Office Vibration Environment 4–26

4.4.4.2	Physical Performance Criteria	4-26
4.4.4.3	Functional Performance Criteria	4-26
4.4.5	Transportation Vibration Criteria	4-27
4.4.5.1	Transportation Environment	4-27
4.5	Airborne Contaminants	4-27
4.5.1	Contamination Classes	4-28
4.5.2	Contamination Levels	4-29
4.5.2.1	Environmentally Controlled Space	4-29
4.5.2.2	Outside Plant (OSP) Equipment	4-31
4.5.3	Measurement of Contaminant Levels	4-32
4.5.4	Equipment - Fan Filters	4-32
4.6	Acoustic Noise	4-33
4.7	Illumination	4-35
4.7.1	Illumination Criteria for Central Office (CO) Lighting Systems	4-35
4.7.1.1	Quantity of Light	4-35
4.7.1.2	Luminance Ratios	4-36
4.7.1.3	Color of Light	4-37
4.7.2	Illumination Criteria for Network Equipment	4-37
4.7.2.1	Surface Reflectance and Color	4-37
4.7.2.2	Glare	4-37

5 Environmental Test Methods

5.1	Temperature, Humidity, and Altitude Test Methods	5-1
5.1.1	Transportation and Storage Test Methods	5-3
5.1.1.1	Low-Temperature Exposure and Thermal Shock	5-4
5.1.1.2	High Relative Humidity Exposure	5-5
5.1.1.3	High-Temperature Exposure and Thermal Shock	5-6
5.1.2	Operating Temperature and Relative Humidity	5-7
5.1.3	Operating Altitude	5-11
5.1.4	Temperature Margin Determination	5-13
5.1.5	Operation with Fan Failure	5-14
5.1.6	Surface Temperature Test Procedures	5-14
5.1.6.1	Infrared Measurement Equipment	5-14
5.1.6.2	Contact Measurement Equipment	5-15
5.1.6.3	Equipment Evaluation Procedures	5-15
5.2	Fire Test Methods	5-16
5.2.1	Testing Clarification - Circuit Board Removal	5-16
5.2.1.1	Case 1 - No Mezzanine Cards	5-16
5.2.1.2	Case 2 - Mezzanine Card	5-17
5.2.1.3	Case 3 - Larger or Multiple Mezzanine Cards	5-18
5.2.2	ANSI T1.319-2003 Test Deviation - Fan Powering Options	5-19
5.2.3	Telcordia Needle Flame Test	5-20
5.2.3.1	Application to Individual Components	5-20
5.2.3.2	In-Situ Application to Individual Components	5-20
5.2.4	Guidelines for Retesting to Address Product Changes	5-21
5.2.5	Test Reporting - Additions	5-22
5.3	Handling Test Methods	5-23
5.3.1	Handling Drop Tests - Packaged Equipment	5-24
5.3.2	Unpackaged Equipment Drop Tests	5-28
5.4	Earthquake, Office Vibration, and Transportation Vibration Test Methods	5-32

- 5.4.1 Earthquake Test Methods 5-32
 - 5.4.1.1 Test Plan 5-34
 - 5.4.1.2 Laboratory Equipment 5-35
 - 5.4.1.3 Test Configuration 5-37
 - 5.4.1.4 Static Test Procedure 5-39
 - 5.4.1.5 Waveform Test Procedure 5-39
 - 5.4.1.6 Test Report 5-40
- 5.4.2 Office Vibration Test Procedure 5-40
- 5.4.3 Transportation Vibration—Packaged Equipment 5-41
- 5.5 Airborne Contaminants Test Methods 5-43
 - 5.5.1 Scope 5-43
 - 5.5.2 Gaseous Contaminants Test Method 5-43
 - 5.5.2.1 Two Cleaning Procedures for Copper Coupons 5-47
 - 5.5.2.2 Test Procedure 5-49
 - 5.5.2.3 Measuring Parameters 5-50
 - 5.5.2.4 Safety Procedures for Testing Gaseous Contaminants 5-51
 - 5.5.2.5 Performance Criteria 5-51
 - 5.5.2.6 Test Report 5-51
 - 5.5.3 Hygroscopic Dust Test Method 5-55
 - 5.5.3.1 Sample Selection 5-55
 - 5.5.3.2 Test Sequence 5-55
 - 5.5.3.3 Performance Criteria 5-56
 - 5.5.3.4 Test Report 5-56
- 5.6 Acoustical Measurement Methodology 5-57
 - 5.6.1 Procedure for Nominal, 27°C (81°F) Operating Conditions: Test Room at 27°C (81°F) 5-57
 - 5.6.2 Procedure for Nominal, 27°C (81°F) Operating Conditions: Test Room at Other Than 27°C (81°F) 5-58
 - 5.6.3 Procedure for Nominal, 23°C (73°F) Operating Conditions 5-58
 - 5.6.4 Procedure for High-Temperature Operating Conditions 5-58
- 5.7 Lighting Test Methods 5-58
 - 5.7.1 Test 1 - Equipment Assembly - Readability, Glare, and Reflectance Tests 5-59
 - 5.7.2 Test 2 - Console Illumination, Readability, and Glare Tests 5-63
 - 5.7.3 Test 3 - Lighting System Tests 5-65

Appendix A: References

- A.1 Telcordia Documents A-1
- A.2 Other Referenced Documents or Material A-2

Appendix B: Acronyms

Requirement-Object Index

List of Figures

Figure 2-1	Framework Base (Typical) — Floor Anchoring Hole Pattern	2-2
Figure 2-2	Typical 6-Lineup Floor Plan for Nominal 300 mm (12-in) Deep Frames	2-4
Figure 2-3	Typical 4-Lineup Floor Plan for Nominal 460 mm (18-in) Deep Frames	2-5
Figure 2-4	Typical Equipment Frame Area (Vertical Section)	2-7
Figure 2-5	Equipment Frame — Overall Dimensions	2-8
Figure 2-6	Typical Equipment Area Using Frames 1829 mm (6 ft, 0 in) High, 762 mm (2 ft, 6 in) Wide, and 610 mm (2 ft, 0 in) Deep	2-11
Figure 2-7	Typical Adapter Plate, Spacer, and Hole Locations in the Top of the Framework	2-13
Figure 2-8	Typical Network Distribution Frame Area	2-15
Figure 2-9	Typical Network DC Centralized Power Plant Equipment Area	2-16
Figure 2-10	Typical Cable Pathways for 305-mm (12-in) Deep Frame Areas (Conventional Cooling System - Air Diffusers)	2-20
Figure 2-11	Typical Cable Pathways for a Distributing Frame Area	2-22
Figure 4-1	Ambient Temperature and Humidity Limits	4-4
Figure 4-2	Profile View of Conforming Equipment Airflow Schemes Dashed Method Is Preferred	4-10
Figure 4-3	Telcordia Earthquake Zone Map	4-23
Figure 4-4	Transportation Vibration Environment	4-27
Figure 5-1	Low-Temperature Exposure and Thermal Shock	5-4
Figure 5-2	High Relative Humidity Exposure	5-5
Figure 5-3	High-Temperature Exposure and Thermal Shock	5-6
Figure 5-4	Operating Temperature and Humidity - Temperature vs. Time for Frame-Level Test	5-9
Figure 5-5	Temperature and Humidity Sensor Locations for Frame-Level Test	5-10
Figure 5-6	Card Removed and Burner Inserted in Plane of PWB	5-17
Figure 5-7	Parent PWB Removed and Burner Inserted - Mezzanine Card Left in Place	5-18
Figure 5-8	Mezzanine Card Removed and Burner Inserted	5-19
Figure 5-9	Drop Surfaces for Category A Container	5-25
Figure 5-10	Test Set-Up for Category A Container	5-26
Figure 5-11	Drop Surface for Category B Container	5-27
Figure 5-12	Category B Container - Equipment Handling Drops	5-28
Figure 5-13	Drop Surfaces for Circuit Pack	5-29
Figure 5-14	Drop Surfaces for Equipment Less Than 25 kg	5-30
Figure 5-15	Drop Surfaces for Equipment More Than 25 kg	5-31
Figure 5-16	Unpackaged Rotational Drops for Equipment More Than 25 kg	5-31
Figure 5-17	Earthquake Synthesized Waveform - VERTEQII- Zone 4	5-33
Figure 5-18	Required Response Spectra	5-34
Figure 5-19	Transportation Vibration Environment	5-42
Figure 5-20	Sample Test Report (Sheet 1 of 2)	5-53
Figure 5-20	Sample Test Report (Sheet 2 of 2)	5-54
Figure 5-21	Test 1 - Equipment Assembly, Readability, and Glare	5-61
Figure 5-22	Test 1 - Equipment Assembly, Surface Reflectance	5-62

Figure 5-23 Console Illumination, Readability, and Glare 5-64
Figure 5-24 Lighting System Test 3, Equipment Distribution Frame Areas . . 5-66
Figure 5-25 Lighting System Test 3, Power and Cable Entrance Areas 5-67

List of Tables

Table 2-1	Vertical Space	2-6
Table 2-2	Summary of Equipment Space and Load Allocations	2-24
Table 4-1	Low-Temperature Exposure and Thermal Shock	4-2
Table 4-2	High Relative Humidity Exposure	4-2
Table 4-3	High-Temperature Exposure and Thermal Shock	4-3
Table 4-4	Ambient ¹ Temperature and Humidity Limits	4-4
Table 4-5	Equipment Area Heat Release Objective	4-8
Table 4-6	Temperature Limits of Touchable Surfaces	4-9
Table 4-7	Category A Container Packaged Equipment Shock Criteria	4-20
Table 4-8	Category B Container Packaged Equipment Shock Criteria	4-20
Table 4-9	Unpackaged Equipment Shock Criteria	4-21
Table 4-10	Correlation of Earthquake Risks	4-22
Table 4-11	Outdoor Contaminant Levels	4-30
Table 4-12	Indoor Contaminant Levels	4-31
Table 4-13	Acoustical Noise Emission Limits	4-34
Table 4-14	Minimum Maintained Illumination Level	4-36
Table 5-1	Application Criteria for Needle Flame Test	5-20
Table 5-2	Response Spectrum Analyzer Frequencies	5-36
Table 5-3	Configuration Guidelines for Shelf-Level Testing	5-38
Table 5-4	Transportation Vibration Test Severity	5-42
Table 5-5	Typical Coupon Weight Gains During MFG Exposures	5-48
Table 5-6	Target Air Composition and Duration of MFG Testing for Equipment Designated for Indoor or Outdoor Use	5-50

Preface

The Telcordia Technologies GR Process

Generic Requirements documents (GRs) provide the Telcordia Technologies view of proposed generic criteria for telecommunications equipment, systems, or services, and involve a wide variety of factors, including interoperability, network integrity, the expressed needs of industry members who have paid a fee to participate in the development of specific GRs, and other input.

The Telcordia GR process implements Telecommunications Act of 1996 directives relative to the development of industry-wide generic requirements relating to telecommunications equipment, including integral software and customer premises equipment. Pursuant to that Act, Telcordia invites members of the industry to participate in the development of GRs. Invitations to participate and the participation fees are published monthly in the *Telcordia Digest of Technical Information*, and posted on the Web, at <http://www.telcordia.com/digest>.

At the conclusion of the GR development process, Telcordia publishes the GR, which is available for license. The license fee entitles the licensee to receive that issue of the GR (GR-CORE) along with any Issues List Report (GR-ILR) and revisions, if any are released under that GR project. ILRs contain any technical issues that arise during GR development that Telcordia and the other participants would like further industry interaction on. The ILR may present issues for discussion, with or without proposed resolutions, and may describe proposed resolutions that lead to changes to the GR. Significant changes or additional material may be released as a revision to the GR-CORE.

Telcordia may also solicit general industry nonproprietary input regarding such GR material at the time of its publication, or through a special Industry Interaction Notice appearing in the *Telcordia Digest of Technical Information*. While unsolicited comments are welcome, any subsequent work by Telcordia regarding such comments will depend on participation in such GR work. Telcordia will acknowledge receipt of comments and will provide a status to the submitting company.

About GR-63-CORE

Participant(s) in the Development of GR-63-CORE, Issue 3

Issue 3 of GR-63-CORE was developed jointly by Telcordia, telecommunications service providers, equipment manufacturers, and testing organizations. The participants in the reissue of this GR follow.

Company Participants	Company Representatives	Company Web Sites
Adtran	Steve Coombs Dan Cassidy Jim Wiese Jeff Whitmire	www.adtran.com
Alcatel USA	Tim Pantalis Charles Young Bobby Brown Mike Shalla Stephane De Francesco	www.alcatel.com
AT&T	Bon Pipkin Mahmoud Elkenaney Larry Wong	https://ebiznet.sbc.com/sbcnebs
Calix Networks	Ted Lord	www.calix.com
Cisco Systems	John Krahnert Chuck Smith	www.cisco.com
Emerson Energy System	Steve Hilbert Joe Piwowar	www.emersonenergy.com
Fujitsu Network Communications	Todd Salisbury Mahesh Mistry Albert Pedoeem	www.fujitsu.com/us
Huawei Company, Ltd.	Luo Shudong Xiang Zishang Fu Taozhi Zhang Guoqing Mike Shern	www.huawei.com
IBM	Curtis Glover Steve Vanderlinden Chuck Jones Matthew Nobile	www.ibm.com
Juniper Networks	Subbu Tallak Sylvia Toma	www.juniper.net
Lucent Technologies	Majid Safavi Ted Lach William Hagmann Hernan Noguchi Joe Bordonaro Michael Downey	www.lucent.com
National Technical Systems	Dan McGinnis Clayton Forbes Mike Rauls	www.ntscorp.com
Sun Microsystems	Lew Kurtz Andrew Han	www.sun.com
UTStarcom	Bill Stamos Scot Salzman Mark Kohler Russ Panzarella Terrel Jones	www.utstarcom.com
Verizon Services	Chuck Graff Andrea Szabo	www.verizonnebs.com
Verizon Wireless	Ron Lang Dan McMenamin	www.verizonwireless.com

Relative Maturity Level, Status, and Plans

Telcordia considers this GR a mature document. The topics addressed in this GR have been in place for a number of years and are considered mature. This reissue contains some new criteria, added within the established topics. Some new and some refined testing methods are also provided. Some of the criteria and test methods are based on available national standards. Others have developed solely for application in this GR. Feedback on all areas of this GR, particularly the new topics and methods, is sought.

Some topics of this GR, such as criteria and test methods for airborne contaminants, were not addressed in this reissue. It is expected that possible changes to these topics will be addressed in a future reissue.

To Submit Comments

When submitting comments, please include the GR document number, and cite any pertinent section and requirement number. In responding to an ILR, please identify the pertinent Issue ID number. Please provide the name and address of the contact person in your company for further discussion.

Send comments to:

Richard Kluge, Director
Telcordia — GR-63-CORE
One Telcordia Drive, Room 4D-660
Piscataway, NJ 08854-4182

Phone: + 1.732.699.5490
FAX: + 1.732.336.3235
E-Mail: rkluge@telcordia.com



1 Introduction

1.1 Purpose and Scope

This Generic Requirements document (GR) presents minimum spatial and environmental criteria for all new telecommunications equipment used in Central Offices (COs) and other environmentally controlled telecommunications equipment spaces. These criteria were developed jointly by Telcordia and industry representatives. They are applicable to switching and transport systems, associated cable distribution systems, distributing and interconnecting frames, power equipment, operations support systems, and cable entrance facilities. Compliance with these requirements may increase network robustness, simplify equipment installation, and promote the economical planning and engineering of equipment spaces.

Telecommunications equipment, by nature of its physical installation in a building, may be exposed to environmental stresses. The generic criteria presented in the following sections are intended to help avoid equipment damage and malfunction caused by such things as temperature and humidity, vibrations, airborne contaminants, minimize fire ignitions and fire spread, as well as provide for improved space planning and simplified equipment installation.

This document provides only those requirements related to the physical aspects of equipment-building interfaces, including physical dimensions and environmental performance criteria. Additional design requirements, including functional, electrical, and reliability requirements, may be found in other requirements documents.

1.2 Service Provider Role

Each telecommunications service provider may choose to include some or all of these requirements in contracts or purchase orders. However, telecommunications service providers may choose not to adopt these requirements. Such a decision is made solely by each telecommunications service provider. Therefore, any supplier or manufacturer is advised to communicate directly with service providers to obtain that company's specific requirements. The requirements of each service provider may vary.

In general, newly-designed systems and associated subassemblies shall be evaluated against the criteria of this issue. Existing systems and subassemblies that have been evaluated and conform to a previous issue of **GR-63-CORE** and that have supporting evidence of such evaluations, do not need to be re-evaluated to this revision. Modified or new subassemblies (e.g, line cards, circuit packs, etc.) intended for systems evaluated using criteria from an earlier issue of **GR-63-CORE** shall be evaluated using the criteria of this issue, and shall conform to the requirements of **GR-209-CORE**, *Generic Requirements for Product Change Notices (PCNs)*.

1.3 Equipment Manufacturer Role

The equipment manufacturer shall, at a minimum, meet its own design standards and design engineering requirements, and all requirements imposed by law. Manufacturing requirements, manufacturing and workmanship standards, and the use of accepted commercial practices supplement the manufacturer's design and engineering criteria, and shall also be met when relevant to product integrity, performance, and reliability.

Product integrity shall be maintained, and there shall be no deviations from physical criteria that adversely affect product safety, reliability, interchangeability, life, performance and operation, quality, maintenance, or aesthetics. The manufacturer shall make any proposal to the telecommunications service provider that will improve the product with respect to these factors. Acceptance of nonconforming products is not the subject of this document. Such decisions are made by the telecommunications service provider or its designated representative. The manufacturer shall propose to the telecommunications service provider any alternatives, deviations, or modifications to its product necessitated by site-specific conditions or other factors.

Products shall be manufactured in accordance with the applicable requirements identified by:

- Federal Communications Commission (FCC)
- National Electrical Code (NEC)
- National Electrical Safety Code (NESC)
- Department of Labor—Occupational Safety and Health Administration (OSHA)
- All other applicable federal, state, and local requirements including, but not limited to, statutes, rules, regulations, orders, or ordinances, or as otherwise imposed by law.

Where requirements are not stated in this document, in contractual technical requirements, or in other applicable documents, the manufacturer's requirements consistent with industry standards shall be met.

Because of the complexity and variety of technologies used in network telecommunications equipment, the criteria of this document cover a wide range of application conditions. Engineering investigation or evaluation of a particular type of equipment may indicate that the specific technology causes certain tests to be unnecessary. In addition, network telecommunications equipment should be performing its design-intended functions, when determining conformance to performance criteria. The performance criteria shall be in accordance with applicable Telcordia Generic Requirements, national and international standards. The decision of applicable tests to be performed and functions for determining performance criteria shall be mutually agreed between manufacturer and telecommunications service provider, or representatives of telecommunications companies. These decisions would be incorporated in a test plan mutually agreed to between a manufacturer and telecommunications service provider or testing laboratory.

1.4 Application Guidelines

1.4.1 COs and Similar Facilities

The criteria of this document are generally applicable to equipment spaces and equipment installed in environmentally controlled telecommunications network facilities such as COs, conditioned commercial facilities, and electronic equipment enclosures.

In general, network equipment at remote locations shall comply with all the spatial and environmental requirements of this document to the extent such spaces provide the described environment.

1.4.2 Commercial Buildings

Network equipment systems also may be installed in non-telecommunications exchange locations, such as commercial buildings. Areas within these buildings that are used exclusively for the installation of communication equipment would be under the control of the service provider. These locations should provide environmental controls similar to those in a CO. To the extent these locations are similar to a CO, the NEBS requirements provided in this document are suitable for the equipment systems installed in these sites. For commercial building environments that differ significantly from COs, the criteria contained in **GR-3108-CORE**, *Generic Requirements for Network Equipment in the Outside Plant (OSP)*, may be more applicable. For some criteria and test methods, **GR-3108-CORE** or other carrier specifications often refer back to portions of this document. Each service provider may also have its own criteria for equipment deployed in commercial building environments.

1.4.3 Non-Environmentally Controlled Locations

Electronic equipment locations and housings without environmental control are generally prefabricated cabinets that are transportable and are normally installed totally above ground on pads or poles. A number of requirements unique to active equipment in these OSP locations, such as resistance to extreme temperatures, salt-fog, fungus, and chemicals are contained in **GR-3108-CORE**. For some criteria and test methods, **GR-3108-CORE** refers back to portions of this document. Each service provider may also have its own criteria for equipment deployed in non-environmentally controlled environments.

1.4.4 Other Locations

Other network equipment locations may have analogous environmental conditions to those examined in this document. For these cases, portions of this document may be referenced for use even if not specifically anticipated during test development. It is expected that these criteria will supplement those developed for other locations either through the GR process or as determined directly by the service provider.

1.5 Reasons for GR-63-CORE, Issue 3

Issue 3 of this GR reflects developments in the industry, as well as the available body of industry standards for telecommunications equipment. The changes include:

- Modified fire-resistance requirements that incorporate new ANSI methods and specific carrier requirements
- A new earthquake and office vibration method for wall-mounted products
- New criteria specifying preferred equipment airflow patterns
- New criteria and test method for thermal-margin testing
- New criteria and test method for evaluating the effect of a fan failure in forced air-cooled products
- Revised acoustic limits based on sound power measurement
- Package shock and vibration testing closely aligned with international standards.

Where major additions or technical changes have occurred in Issue 3, the location of the change is marked by a vertical bar (|) in the outer margin next to the change.

The new requirements for Issue 3 begin at absolute number [146]. GR-63-CORE, Issue 3, completely replaces GR-63-CORE, Issue 2.

1.6 Structure and Use of This Document

This document is organized as follows:

- [Section 1, “Introduction”](#)
- [Section 2, “Spatial Requirements”](#) - Provides requirements for equipment and cabling systems to be compatible with CO vertical and horizontal space allocations and floor loading limits. Part of this overall scheme is the cable pathways plan that coordinates the overhead cable distribution by allocating the system and via cable to different levels, both parallel and transverse to equipment frame lineups.
- [Section 3, “NEBS-2000 Framework Criteria”](#) - This section formerly contained NEBS-2000 Framework Criteria, but now contains a reference to **ANSI T1.336-2003**, *Engineering Requirements for a Universal Telecom Framework*.
- [Section 4, “Environmental Criteria”](#) - Provides requirements for equipment to help ensure compatibility with the physical environment provided by network facilities. This environment includes physical stresses from temperature, humidity, fire, earthquake and airborne contaminants, as well as the acoustic noise and illumination characteristics of these facilities. The requirements should apply to all new equipment systems deployed in COs and other environmentally controlled telecommunications equipment spaces.
- [Section 5, “Environmental Test Methods”](#) - Presents test methods that should be used to test equipment for conformance to the environmental requirements set forth in Section 4.

- **Appendix A, “References”** - Lists the documents referenced in this GR.
- **Appendix B, “Acronyms”** - Defines acronyms used in this GR.
- **“Requirement-Object Index”**- Lists all generic requirements and their location in this GR.

1.7 Related Documents

GR-63-CORE is a subset of a family of documents for physical and environmental criteria for COs and other environmentally controlled telecommunications network buildings and for the equipment used in these facilities. Since many users of NEBS documents typically need the full set of documents, Telcordia bundles these inter-related documents into one cohesive Family of Requirements (FR) set, **FR-2063, Network Equipment-Building System (NEBS™) Family of Requirements**.

FR-2063 includes this document (GR-63-CORE) and the following documents:

- **GR-1089-CORE, *Electromagnetic Compatibility and Electrical Safety - Generic Criteria for Network Telecommunications Equipment***, identifies the minimum generic criteria for Electromagnetic Compatibility (EMC) and electrical safety necessary for equipment to perform reliably and safely in a telecommunications network environment. It places in a single reference document, EMC and electrical safety criteria for equipment used at a CO location; equipment placed in OSP locations such as controlled environmental vaults, electronic equipment enclosure, and huts; equipment located in uncontrolled structures such as cabinets; and network equipment located at the customer premises.
- **SR-3580, *NEBS™ Criteria Levels***, groups the criteria of **GR-63-CORE** and **GR-1089-CORE** into three levels. The levels allow for incremental conformance to the NEBS criteria.
- **GR-78-CORE, *Generic Requirements for the Physical Design and Manufacture of Telecommunications Products and Equipment***, identifies the minimum generic physical design criteria that are, in the opinion of Telcordia, currently appropriate for products and equipment used in a telecommunications network. **GR-78-CORE** applies to equipment placed in the controlled environment of a CO, or in controlled environmental locations placed outdoors, or in uncontrolled structures.

1.8 Requirements Terminology

The following requirements terminology is used throughout this document:

- **Requirement** — Feature or function that, in the view of Telcordia, is *necessary* to satisfy the needs of a typical client company. Failure to meet a requirement may cause application restrictions, result in improper functioning of the product, or hinder operations. A Requirement contains the words *shall* or *must* and is flagged by the letter “**R**.”
- **Conditional Requirement** — Feature or function that, in the view of Telcordia, is *necessary in specific applications*. If a client company identifies a

Conditional Requirement as necessary, it shall be treated as a requirement for the application(s). Conditions that may cause the Conditional Requirement to apply include, but are not limited to, certain client companies' application environments, elements, or other requirements, etc. A Conditional Requirement is flagged by the letters "CR."

- **Objective** — Feature or function that, in the view of Telcordia, is *desirable* and may be required by a client company. An Objective represents a goal to be achieved. An Objective may be reclassified as a Requirement at a specified date. An objective is flagged by the letter "O" and includes the words *it is desirable* or *it is an objective*.
- **Conditional Objective** — Feature or function that, in the view of Telcordia, is *desirable in specific applications* and may be required by a client company. It represents a goal to be achieved in the specified Condition(s). If a client company identifies a Conditional Objective as necessary, it shall be treated as a requirement for the application(s). A Conditional Objective is flagged by the letters "CO."
- **Condition** — The circumstances that, in the view of Telcordia, will cause a Conditional Requirement or Conditional Objective to apply. A Condition is flagged by the letters "Cn."

1.9 Requirement Labeling Conventions

As part of the Telcordia GR Process, proposed requirements and objectives are labeled using conventions that are explained in the following two sections.

1.9.1 Numbering of Requirement and Related Objects

Each Requirement, Objective, Condition, Conditional Requirement, and Conditional Objective object is identified by both a local and an absolute number. The local number consists of the object's document section number and its sequence number in the section (e.g., **R3-1** is the first Requirement in Section 3). The local number appears in the margin to the left of the Requirement. A Requirement object's local number may change in subsequent issues of a document if other Requirements are added to the section or deleted.

The absolute number is a permanently assigned number that will remain for the life of the Requirement; it will not change with new issues of the document. The absolute number is presented in brackets (e.g., **[2]**) at the beginning of the requirement text.

Neither the local nor the absolute number of a Conditional Requirement or Conditional Objective depends on the number of the related Condition(s). If there is any ambiguity about which Conditions apply, the specific Condition(s) will be referred to by number in the text of the Conditional Requirement or Conditional Objective.

References to Requirements, Objectives, or Conditions published in other Generic Requirements documents will include both the document number and the Requirement object's absolute number. For example, **R2345-12** refers to Requirement **[12]** in GR-2345-CORE.

1.9.2 Requirement, Conditional Requirement, and Objective Identification

A Requirement object may have numerous elements (paragraphs, lists, tables, equations, etc.). To aid the reader in identifying each part of the requirement, rules are used above and below requirement content.

Introductory information.

Content of Requirement object(s).

2 Spatial Requirements

2.1 General Requirements

The following criteria apply to equipment frames, distribution and interconnecting frames, and dc power plant equipment. Additional requirements unique to each of these are in Sections 2.2, 2.3, and 2.4, respectively.

-
- R2-1 [1]** All equipment frames shall have a hole pattern on a flat horizontal surface on the base of the frame for anchoring to building floors. The hole pattern shall permit lateral relocation of the fasteners to avoid interference with reinforcement bars. Access to the anchoring hardware with electronics in place and operating is required for verification that hardware continues to meet torque requirements. Use [Figure 2-1](#) as a guide.

The equipment-base floor anchor bolt system shall be designed so the equipped framework can be fitted laterally into its space under an existing cable distribution system and then secured to the building floor with appropriately sized anchors. See [Section 4.4.2](#) for concrete expansion anchor criteria.

-
- R2-2 [2]** The frame base and anchoring method shall provide for a self-supporting equipment frame that can withstand overturning moments caused by cable-pulling or earthquake effects without auxiliary support or bracing from the ceiling or side walls. As a minimum, the floor anchoring method shall withstand the overturning load of a 450 N (*100 lbf*) applied at the top of the frame in any horizontal direction.

-
- R2-3 [3]** Any frame, when packaged for transit and accompanied or supported by the usual handling facilities, shall fit through typical equipment entrances 1219 mm (*4 ft*) wide and 2438 mm (*8 ft*) high.

To help ensure that different types of frames fit together to form orderly, straight equipment frame lineups, all frames shall comply with the following criteria:

-
- O2-4 [4]** Frames of only one depth should be used in a frame lineup.

-
- R2-5 [5]** No part of any frame or apparatus attached to the frame (including installed cables) shall extend horizontally beyond the front or rear edges of the base (or guardrail) of the frame. Frame-base extenders may be used to increase the effective base depth.

-
- R2-6 [6]** Means to level and plumb the frames and to compensate for variation in floor flatness, such as wedges, shims, or leveling screws, shall be part of, or available for, the frame.
-

Figure 2-1 Framework Base (Typical) — Floor Anchoring Hole Pattern

Hole Pattern A

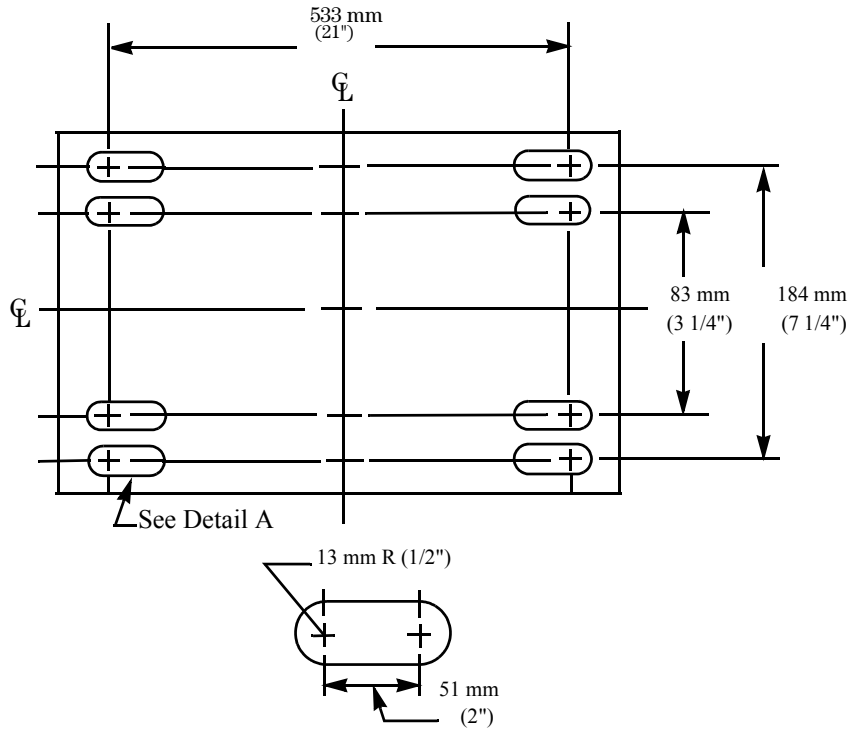

Detail A (Enlarged View)

Hole Pattern B

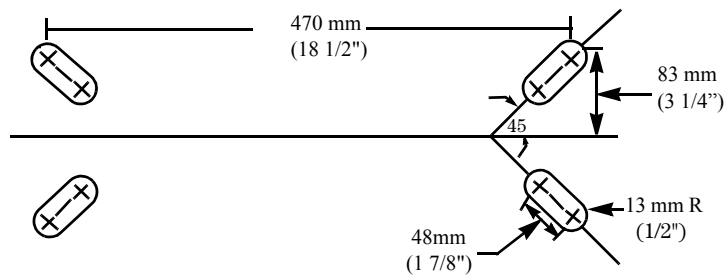

O2-7 [7] The fronts of the base of all frames should be aligned.

O2-8 [8] In the lineup, side clearance of at least 2 mm (0.08 in) should be provided between adjacent frames.

2.1.1 Equipment Frame Floor Plans

O2-9 [9] Floor plans should provide a high degree of standardization while maintaining enough flexibility to permit natural growth from the initial to the ultimate equipment configuration. For 300 mm nominal (*12-in*) deep frames, the 6-lineup plan shown in [Figure 2-2](#) should be used.

R2-10 [146] Minimum aisle spacing for the all equipment areas shall be nominal 760 mm (*2 ft, 6 in*) for the maintenance aisle and nominal 600 mm (*2 ft*) for the wiring aisle.

R2-11 [147] Minimum main aisle spacing for all equipment areas shall be nominal 1200 mm (*4 ft*) between groups of equipment lineups.

For multiframe systems with high heat release, excessive weight or great quantities of cabling, the aisle spacings should be increased to limit the floor loading to less than 560 kg/m² (*114.7 lb/ft²*) per [Section 2.2.4, “Equipment Frame Floor Loading,”](#) and/or heat dissipation to less than 860 W/m² (*79.9 W/ft²*) per [Table 4-5. Figure 2-3](#) illustrates a floor plan for nominal 460 mm (*18-in*) deep frames which require the wider aisle spacing to meet the above criteria.

Equipment frames that can be maintained and wired from the front can be located along a wall with a 75 mm (*3-in*) rear clearance. These frames are preferred for remote terminal applications.

Not all frames can be used in the standard floor layouts. For example, it may be necessary to include lineups of different depths in one building bay, or a special frame may require an exceptionally wide maintenance aisle. Such cases may dictate nonstandard floor plans. Plans should, however, adhere to the 700-kg/m² (*143.4-lb/ft²*) floor-load allocation for all equipment, including cable and lights.

O2-12 [10] Floor plans should be designed to ensure that all equipment functions together effectively without excessive special engineering or poor use of building space and services.

O2-13 [11] Floor plans for equipment on raised floors should permit the removal of floor panels in the aisles without disturbing the equipment frames.

2.1.2 NEBS Data (ND)

R2-14 [12] This requirement has been deleted per Issue 2.

Figure 2-2 Typical 6-Lineup Floor Plan for Nominal 300 mm (12-in) Deep Frames

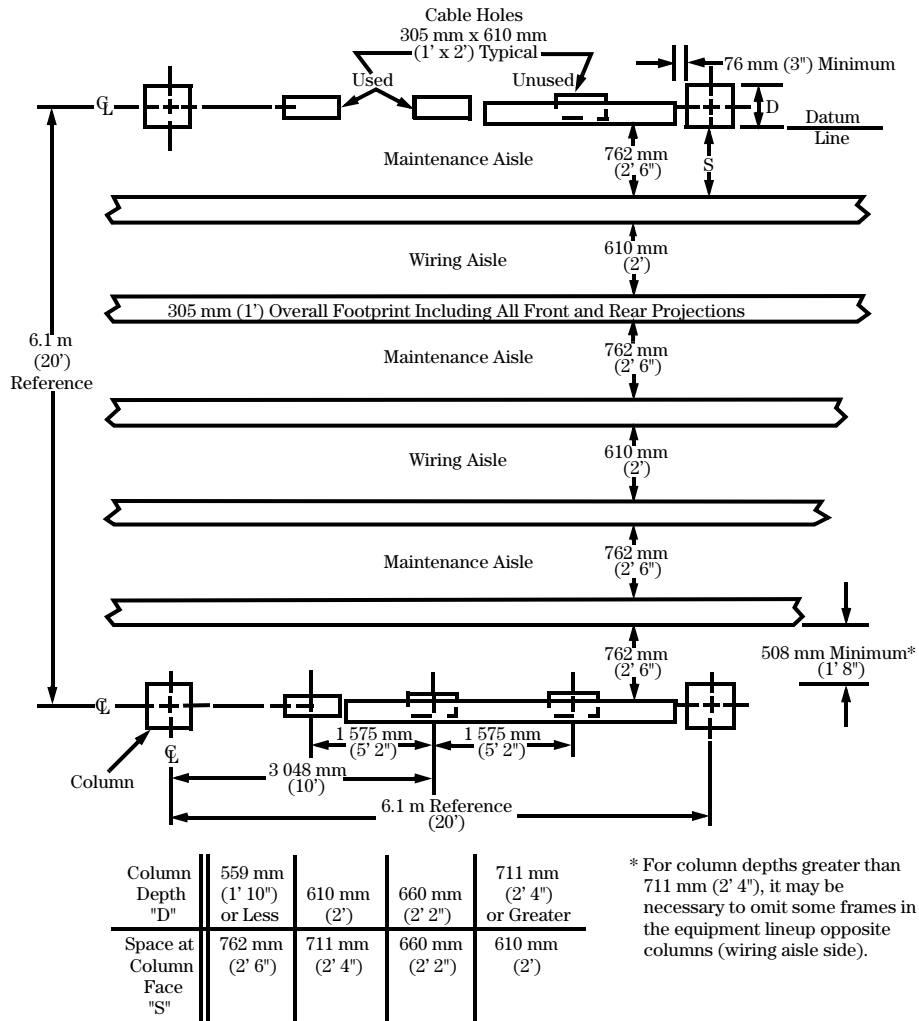
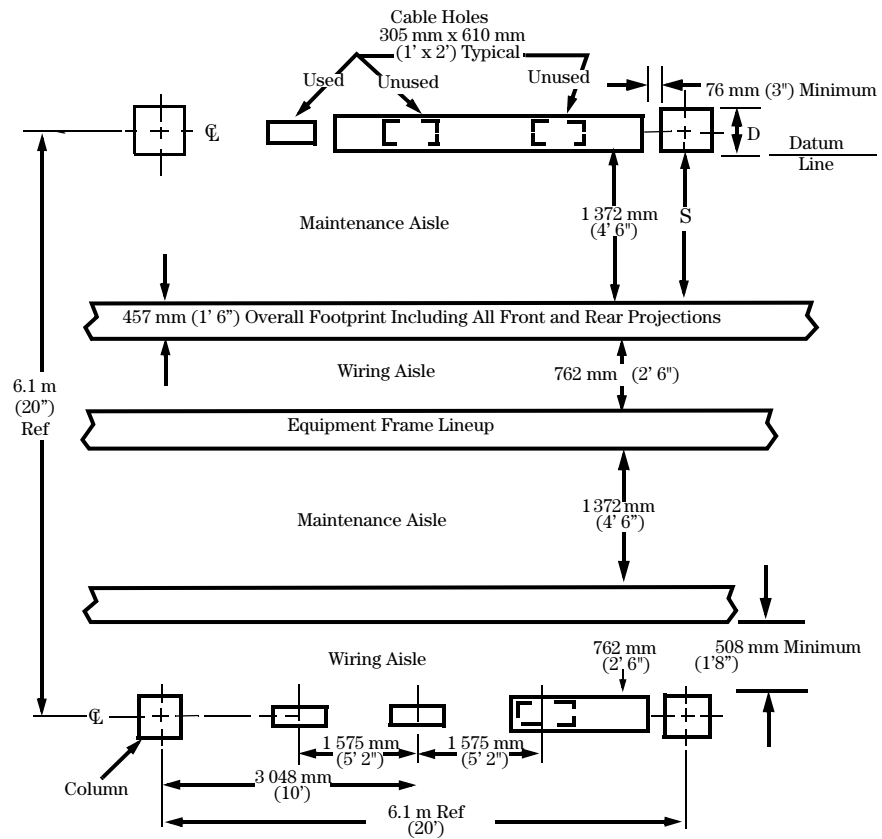

Figure 2-3 Typical 4-Lineup Floor Plan for Nominal 460 mm (18-in) Deep Frames



Column Depth "D"	559 mm (1' 10") or Less	610 mm (2')	660 mm (2' 2")	711 mm (2' 4") or Greater
Space at Column Face "S"	1 372 mm (4' 6")	1 321 mm (4' 4")	1 270 mm (4' 2")	1 219 mm (4')

2.2 Equipment Frames

An equipment frame consists of a structural framework that occupies floor space and all the equipment mounted on it. Examples of frames include cabinets, relay racks, consoles, disk and tape drivers, and battery stands. This section covers all the types of frames that may be installed in lineups in equipment areas of network facilities.

2.2.1 Vertical Space Allocation in an Equipment Frame Area

Figure 2-4 shows the typical configuration for an equipment frame area. On the left side of the figure is the typical configuration for conventional cooling systems. These all-air systems usually use central fan rooms, overhead ducts, and diffusers to distribute air. On the right side, is the typical configuration for a modular cooling system that may be used in equipment areas with high-heat dissipation. These systems may feature combinations of one or more of the following: water-cooled process coolers located among the equipment frames, plenum raised floors or plenum ceiling for local air distribution, chilled water piping, and some cabling.

The vertical space is typically allocated as shown in Table 2-1:

Table 2-1 Vertical Space

Below raised floor (when used)	Air supply plenum, mechanical and electrical services, or cabling
Floor (or top of raised floor) to 3048-mm level (<i>10-ft level</i>)	Equipment frames, cable distribution, and lights
Over 3048-mm level (<i>10-ft level</i>)	Cooling air ducts and diffusers or air supply plenum

Figure 2-4 Typical Equipment Frame Area (Vertical Section)

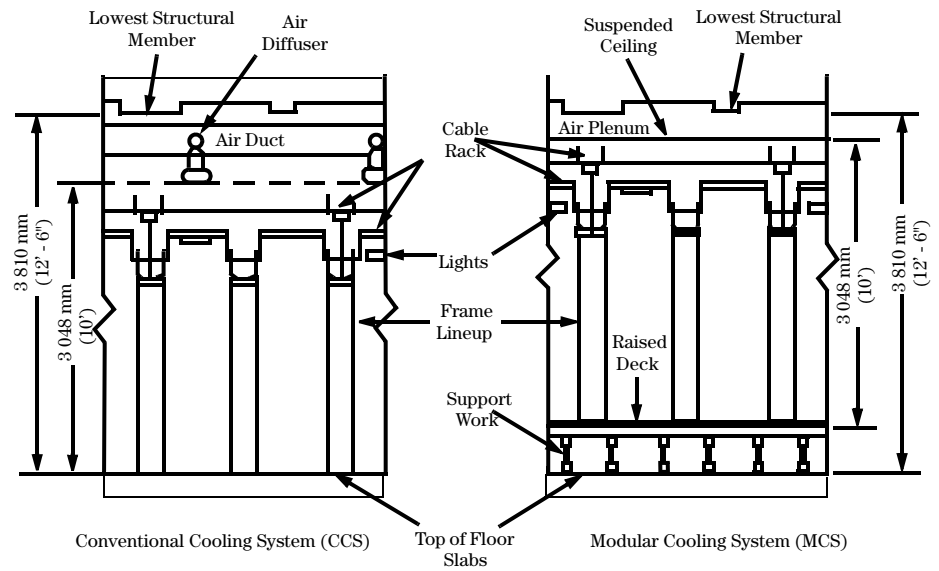

2.2.2 Equipment Frame Dimensions

Figure 2-5 shows the conventional nomenclature for overall dimensions of equipment frames.

These dimensions include any equipment that is part of the frame or routinely left attached to the frame, particularly any front or rear projections, such as knobs, paper guides, or cable.

Figure 2-5 Equipment Frame — Overall Dimensions

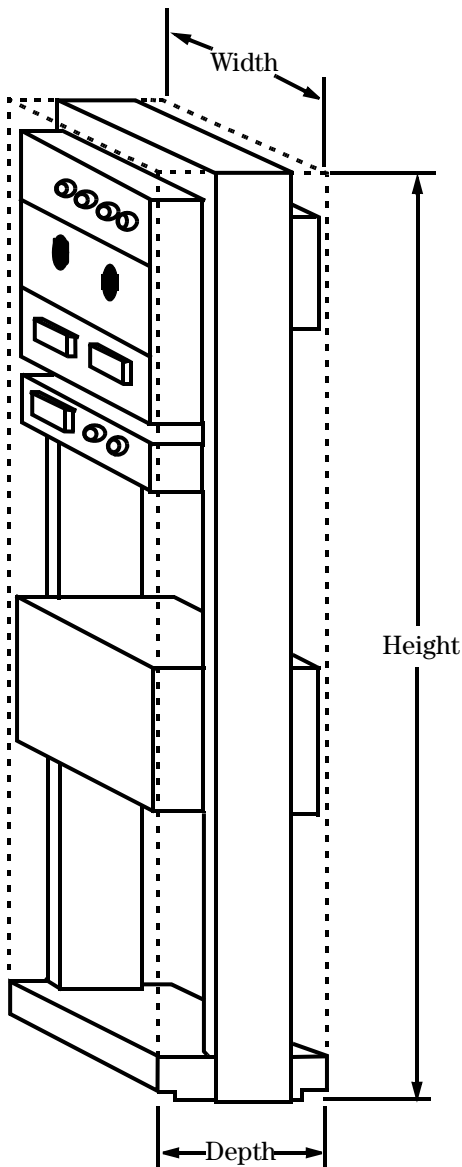

O2-15 [13] Frames with their system cable racks should not exceed 2743 mm (9 ft) in height above the floor.

A frame with its system cable racks exceeding a height of 2743 mm (9 ft) may be used with the requirements in this document. In offices with a clear ceiling height of 3810 mm (12 ft, 6 in), the above frame will reduce the vertical space allocated to via racks and the mechanical systems.

2.2.2.1 Equipment Frame Dimensions - Open Style Racks

Many equipment areas use open style racks to support equipment chassis or shelves. These racks are very common in transport and common systems areas of network facilities. A number of common rack dimensions are used and standards such as **EIA-310-D**, *Cabinets, Racks, Panels, and Associated Equipment*, address the detail engineering of these products.¹

- O2-16 [14]** Open style equipment racks should have the following nominal overall dimensions:

Height	Nominal 2130 mm (<i>7 ft</i>)
Width	Nominal 560 mm (<i>23 in</i>) for 19-inch equipment Nominal 660 mm (<i>26 in</i>) for 23-inch equipment
Depth	Nominal 300 mm (<i>12 in</i>)

In CO applications, the wider width is the most common. Chassis suitable for mounting in a 560 mm rack can be supported by the wider rack via alternative mounting hardware or adapters. Chassis deeper than 300 mm (*12 in*) can be supported in open-style racks if base extenders are used as required by **R2-5 [5]**.

Base extenders are commercially available and are provided by rack suppliers to protect equipment that protrudes beyond the standard rack base.

- O2-17 [148]** Open-style racks should not be used for products deeper than 600 mm (*24 in*) even when base extenders are used.

- O2-18 [149]** For chassis depths ≥ 450 mm (*18 in*), provisions to fasten the chassis to both front and rear faces of the rack mounting flange are desirable.

2.2.2.2 Equipment Frame Dimensions - Other Rack Styles

Some newer equipment areas use other rack styles, such as four-post racks or cabinets, to support equipment chassis or shelves. These racks may be open in construction (similar to the traditional open style racks) or may be enclosed by doors, side panels, or tops. Regardless of the construction details, these frameworks are usually provided in depths greater than 300 mm (*12 in*) and are able to support deeper chassis than traditional open style racks. A number of sizes are available, but the following are most desirable for efficient allocation of space. The engineering and performance of these products are detailed in **ANSI T1.336-2003**, *Engineering Requirements for a Universal Telecom Framework*.

1. **EIA-310-D** specifies a usable opening of 19-inch racks to be 17.750 inches, while rack vendors fabricate seismic-compliant racks with an opening of 17.500 inches.

O2-19 [150] Equipment racks for newer equipment areas or to support deeper chassis should have the following nominal overall dimensions:

Height	Nominal 2130 mm (<i>7 ft</i>)
Width	Nominal 600 mm (<i>24 in</i>), or Nominal 750 mm (<i>30 in</i>)
Depth	Nominal 600 mm (<i>24 in</i>), or Nominal 750 mm (<i>30 in</i>), or Nominal 900 mm (<i>36 in</i>)

2.2.2.3 Equipment Frame Dimensions - Special Cases

Frames may exceed the objective dimensions for width and depth when placed in a special lineup where the minimum maintenance and wiring aisles can be maintained and the interface with the cable rack can be engineered.

Switching systems with lineups of equipment that include system cable racks may deviate from the objective dimensions. Such systems must still meet the requirements for lineup conformity in [Section 2.1, “General Requirements.”](#) [Figure 2-6](#) is an example of a floor plan of a switching system for illustrative purposes.

Figure 2-6 Typical Equipment Area Using Frames 1829 mm (6 ft, 0 in) High, 762 mm (2 ft, 6 in) Wide, and 610 mm (2 ft, 0 in) Deep

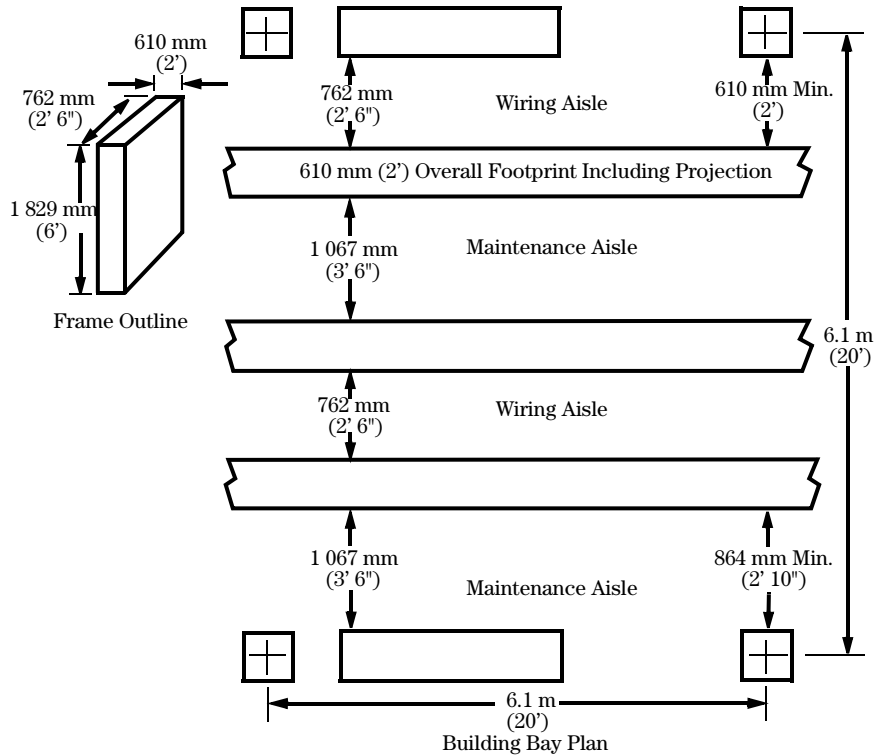

2.2.2.4 Equipment Frame Cable Management Provisions

R2-20 [151] All framework shall provide access to permit cabling from top or bottom.

O2-21 [152] All framework should be manufactured to allow orderly placement of larger cables, i.e., power conductors, such that these do not interfere with access to equipment mounted in the framework, each other, or other cables routed into the framework.

2.2.2.5 Equipment Frame Interface with Cable Rack

R2-22 [15] Equipment frames shall be capable of supporting and providing a fastening arrangement for all system Cable Distribution Systems (CDSs). The design of the interface between the frame and CDS shall permit the insertion or removal of a frame from an equipment lineup. To permit this insertion or removal, a minimum clearance of 10 mm (0.39 in), except for spacers, shall normally be provided between the top of the frames and the bottom of the CDS.

- O2-23 [16]** Framework top cross-member should provide the following fastenings: a minimum of two 13-mm (*0.51-in*) diameter holes (with room for a nut) or two M10 (*or 3/8 - 16*) tap-through holes (with at least four full threads). The holes shall be located on the longitudinal center line and 121 mm (*4.75 in*) to either side of the front-to-back center line of the framework top, as [Figure 2-7](#) shows.

When the fastenings in the top of the framework do not align with the holes in the system lineup rack, an adapter plate that mounts on the top of the framework may be used as [Figure 2-7](#) shows.

2.2.3 Equipment Frame Lineup Conformity

- R2-24 [17]** End guards for equipment frames shall be as wide as the equipment frames are deep and extend the full height of the frame. The minimum aisle spacings must be maintained when the end guards are added to an equipment lineup.

2.2.4 Equipment Frame Floor Loading

- O2-25 [18]** An individual frame should be limited to a floor load of 560 kg/m^2 (114.7 lb/ft^2). The floor load for an equipment frame is calculated by dividing the frame weight by the area of a rectangle bounded by the extended frame sides and the center line of the standard front (762 mm or $\{2 \text{ ft}, 6 \text{ in}\}$) and rear (610 mm or $\{2 \text{ ft}\}$) aisles.
- R2-26 [19]** An equipment frame shall be able to support all overhead CDSs and lights located up to 3048 mm (10 ft) above the floor and having a maximum weight of 125 kg/m^2 (25.6 lb/ft^2). In partially equipped lineups, CDSs and lights may be partially supported by floor-mounted stanchions. Over unequipped areas, via CDSs (defined in [Section 2.5](#)) may be supported by stanchions or from the ceiling.

In addition to the 560-kg/m^2 (114.7-lb/ft^2) equipment frame load and the 125-kg/m^2 (25.6-lb/ft^2) CDS and lighting fixture load, there is a 50-kg/m^2 (10.2-lb/ft^2) transient load. The sum of these individual loads equals the floor-loading limit of 735 kg/m^2 (150.6 lb/ft^2).

Figure 2-7 Typical Adapter Plate, Spacer, and Hole Locations in the Top of the Framework

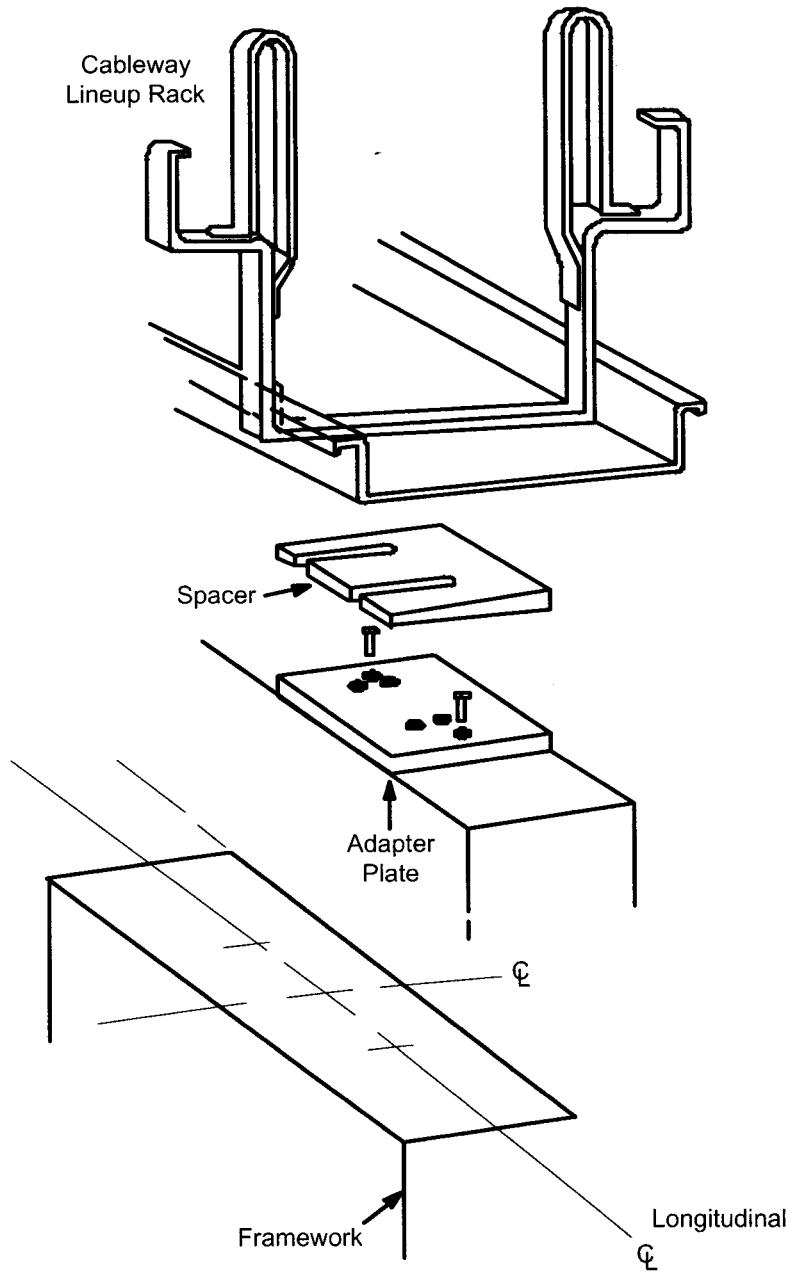

2.2.5 AC Convenience Outlets Within Equipment Frames

- R2-27 [20]** The base of each frame, behind the front and rear guardrails, shall have space for ac power distribution for convenience outlets. The sides of the frame base must be sufficiently open or have holes that permit distribution wire to run through the frames. The front and rear of the frame base and/or guardrail shall provide the means and location for convenience outlets. When design control for a system includes the end guards at both ends of a lineup, the convenience outlets may be located in the end guards instead of in the base of each individual frame.
- R2-28 [21]** Alternating current power distribution for connecting outlets or lighting fixtures that may be part of the frame assembly shall be designed and constructed to comply with the National Electrical Code (NEC), except where those requirements are superseded by applicable local electrical and building codes.

2.3 Distributing and Interconnecting Frames

This section presents spatial and floor loading requirements that are unique to distributing frames and interconnecting frames.

2.3.1 Distributing Frames (DFs)

Distributing Frames serve as a common termination point for the interconnection of metallic OSP cabling, and CO equipment interfaces. DFs provide protection, cross-connection, and test access to equipment and cabling. DFs are not installed in lineups with other equipment frames. Samples of type of DFs include the following:

- Main Distributing Frame (MDF)
- Protector Frame (PF).

Figure 2-8 shows a typical network distributing frame area. Objectives and requirements for the frames (which include associated overhead dedicated cabling and cable racks) are described below.

- O2-29 [22]** Frames should have a maximum height of 2743 mm (*9 ft*) including associated system cabling, which includes all terminating cabling and racks. The space from 2743 mm to 3048 mm (*9 to 10 ft*) should be shared between the system and non-terminating via cabling. In long DF lineups, system cabling may be more than 2743 mm (*9 ft*), but must be less than 3505 mm (*11 ft, 6 in*) above the floor.

Nonconforming frames may be used with the requirements in this document; however, special consideration is necessary to ensure the frame cabling will not interfere with via cabling, air ducts, or other building systems.

- R2-30 [23]** Frames shall have a maximum floor load of 675 kg/m² (*138.3 lb/ft²*). This uniform load is the total weight of all distributing frame equipment in the area, including cabling and racks, divided by the associated floor area, including aisles. When such areas exceed 37.2 m² (*400 ft²*), any 6.1-m × 6.1-m portion (*20-ft × 20-ft*),

regardless of its location relative to the columns, should not exceed the floor-load requirement.

- 02-31 [24]** Frames should be capable of supporting all overhead cable distribution systems and lights. In partially equipped lineups, cabling and lights may be supported by floor-mounted stanchions.

Figure 2-8 Typical Network Distribution Frame Area

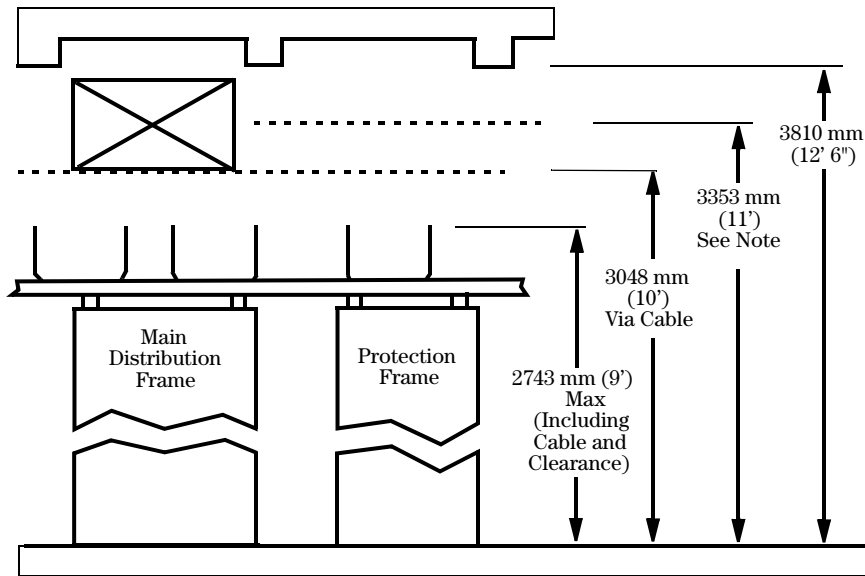

Note: The space between the 3048 mm (10') and 3353 mm (11') levels is normally reserved for air conditioning ducts, but over the main frame this space may be required for cable pileups.

2.3.2 Interconnecting Frames (IFs)

Interconnecting Frames provide for cross-connection and test access of CO equipment and cabling, as well as fiber optic cabling that may originate from the OSP. (OSP metallic cabling does not terminate on the IF.) IFs may be installed in lineups with equipment, or in separate lineups parallel or perpendicular to equipment frame lineups. Examples of IFs include the following:

- Intermediate Distributing Frame (IDF)
- Circuit Concentration Bay (CCB)
- Group Distributing Frame (GDF)
- Digital System Cross-connect (DSX)
- Quick Connect and Cross-connect (QCX)
- Trunk Distributing Frame (TDF)

- Fiber Distributing Frame (FDF).

IFs are subject to all equipment frame criteria of [Section 2.2, “Equipment Frames.”](#)

2.4 DC Power Plant Equipment

This section presents spatial and floor loading requirements that are unique to dc power plant equipment.

2.4.1 Centralized DC Power Plant Equipment

Centralized DC Power Plant Equipment — encompasses dc power plant equipment that is located in a separate “power room” or designated “power plant equipment area.” Such centralized DC power plants are typically separate from the equipment frame areas. A single power plant may serve one or more load equipment systems.

-
- R2-32 [25]** The height of centralized dc power plant equipment, including all superstructure and overhead facilities such as cable, cable racks, and bus bars, shall not exceed 3048 mm (10 ft). This vertical space allocation also includes any vertical clearance (headroom) necessary for installation, operation, and maintenance. [Figure 2-9](#) shows a typical centralized dc power plant equipment area.
-

Figure 2-9 Typical Network DC Centralized Power Plant Equipment Area

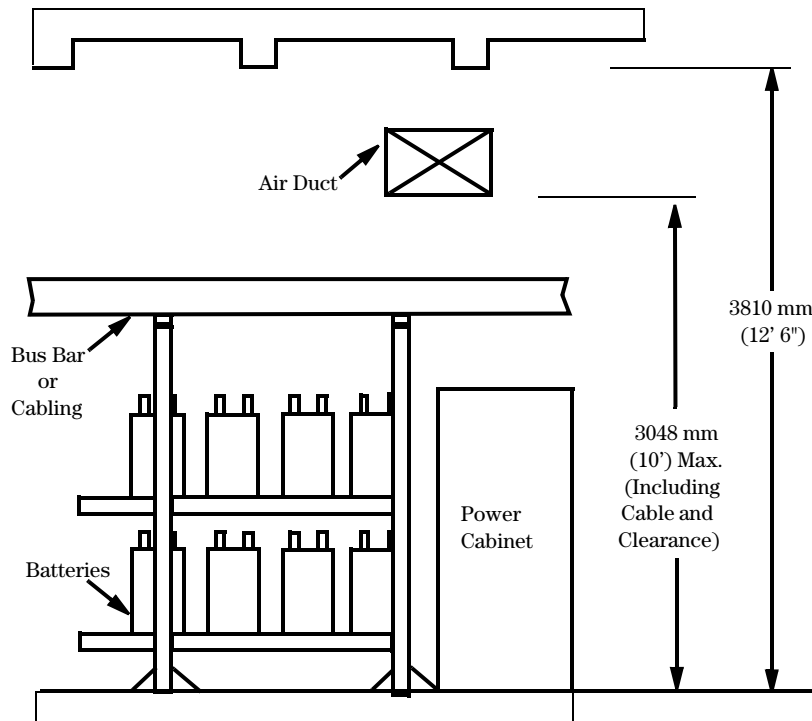

R2-33 [26] This requirement has been superseded by **R2-10 [146]** in Issue 3.

O2-34 [27] Equipment frames should be capable of being installed on building floor structures having a total floor load capacity of 735 kg/m^2 (150.6 lb/ft^2). Centralized dc power plant frames are allocated 700 kg/m^2 (143.4 lb/ft^2) with 50 kg/m^2 (10.2 lb/ft^2) allocated for transient loads (see [Section 2.2](#)).

System design considerations and individual site characteristics (e.g., base slab installations or existing high-capacity floor structures) may justify the use of floor loadings greater than 700 kg/m^2 (143.4 lb/ft^2) for centralized dc power plant equipment. A frame that exceeds the 700 kg/m^2 requirement is designated a concentrated load and may require site-specific engineering.

O2-35 [28] Centralized dc power plant equipment should support all overhead CDSs, bus bars, and lights. In partially equipped areas, these elements may be supported by floor-mounted stanchions. Centralized dc power plant equipment shall be designated for base-mounted attachment to the floor without auxiliary support or bracing from the ceiling or side walls. When so supported, centralized dc power plant equipment shall be capable of withstanding the network environments, including the earthquake environments, that [Section 4, “Environmental Criteria,”](#) describes.

Lineup or Frame-Mounted DC Power Equipment — dc power plant equipment units that can be installed in equipment frame lineups as [Section 2.1](#) and [Section 2.2](#) discuss. The criteria in [Section 2.1](#) and [Section 2.2](#) apply to line-up dc power equipment.

2.5 Cable Distribution Systems (CDSs)

CDSs consist of cable, racks, and supports and are grouped into two categories:

- **System CDSs** — CDSs designed for exclusive use with, and dedicated to, a particular equipment system. They are used for cabling frames within a system. In this context, system means a number of frames and associated cables, all with a single major function.
- **Via CDSs** — CDSs designed to transport cable that originates outside a particular equipment system and passes over it, or terminates in it. Via racks include vertical cable runs in multi-story facilities. They usually consist of ladder or bar-type racks.

2.5.1 CDS Requirements

2.5.1.1 General

CDSs shall conform to the earthquake and office vibration requirements of [Section 4.4, “Earthquake, Office Vibration, and Transportation Vibration.”](#)

2.5.1.2 Overhead Cable Distribution

The CDS should provide cable pathways that are located, sized, and allocated to meet the requirements of [Section 2.5.2, “Cable Pathways Over Equipment Frame Areas,”](#) as appropriate.

- O2-36 [29]** At least one (1) cross-aisle pathway per building bay should be reserved for via cabling.
- O2-37 [30]** System and via lineup racks should be centered over the equipment lineups to minimize interference with installer access, and air and light distribution in the aisles.
- O2-38 [31]** System CDSs should be supported by the associated equipment frames/cabinets, or by stanchions in partially equipped lineups, with provision for inserting or removing frames/cabinets from a lineup. Via CDSs may be supported by the frames/cabinets or from the ceiling.
- O2-39 [32]** System CDSs should be coordinated with frame-and-aisle lighting so the system conforms to the illumination requirements of [Section 4.7, “Illumination.”](#)
- O2-40 [33]** System CDSs should provide adequate clearance for transporting frames in an erected position through the maintenance aisle.

2.5.1.3 Cable Distribution Under Raised Floor

Some designs may provide an option for system cabling to be installed under a raised floor. In this case, overhead space allocations for system CDSs may be traded for space under the floor. Requirements for overhead via CDSs do not change.

- R2-41 [34]** Cabling under the raised floor shall conform to the requirements of the NEC and applicable state and local codes.
- R2-42 [35]** The underfloor CDS shall provide for monitoring with smoke detectors and for protecting the cables against malfunctions caused by water leaks and dampness.

O2-43 [36] Communication cables should be segregated from power cables to avoid physical damage and electrical interference.

2.5.2 Cable Pathways Over Equipment Frame Areas

Above 2134-mm (*7-ft*) high equipment, the 2134-mm to 3048-mm (*7-ft to 10-ft*) cable pathways space is typically allocated between system and via cable racks, lights, passages for cooling air, and installer access. This section specifies the plan for allocating cable pathways.

2.5.2.1 Elements of Allocation Plan

The cable pathway plan coordinates the locations of elements of the equipment-building system, including the structural columns, cable holes, ceiling inserts, cooling air ducts and diffusers, smoke detectors, equipment frame lineups, cable racks, and equipment aisle lighting. Specifically, the plan provides system and via cable pathways at different levels, both parallel and perpendicular to equipment frame lineups. It creates large unobstructed openings between cross-aisle pathways. The pathways permit cooling air to flow down to equipment from or above the 3048-mm (*10-ft*) level, and provide good access to all cable racks. The plan ensures vertical cable holes are not blocked by cable pathways, and lights are placed in an ideal location. The air flow from the top of the equipment frames should not be blocked by cable trays, lighting fixtures, or other large impediments.

Figure 2-10 shows a typical plan for 305-mm (*12-in*) deep frames. This plan can be adjusted to work in buildings with different column and cable-hole spacings. Cable pathways dedicate the various spaces during the life of the equipment-building system.

Figure 2-10 Typical Cable Pathways for 305-mm (12-in) Deep Frame Areas
(Conventional Cooling System - Air Diffusers)

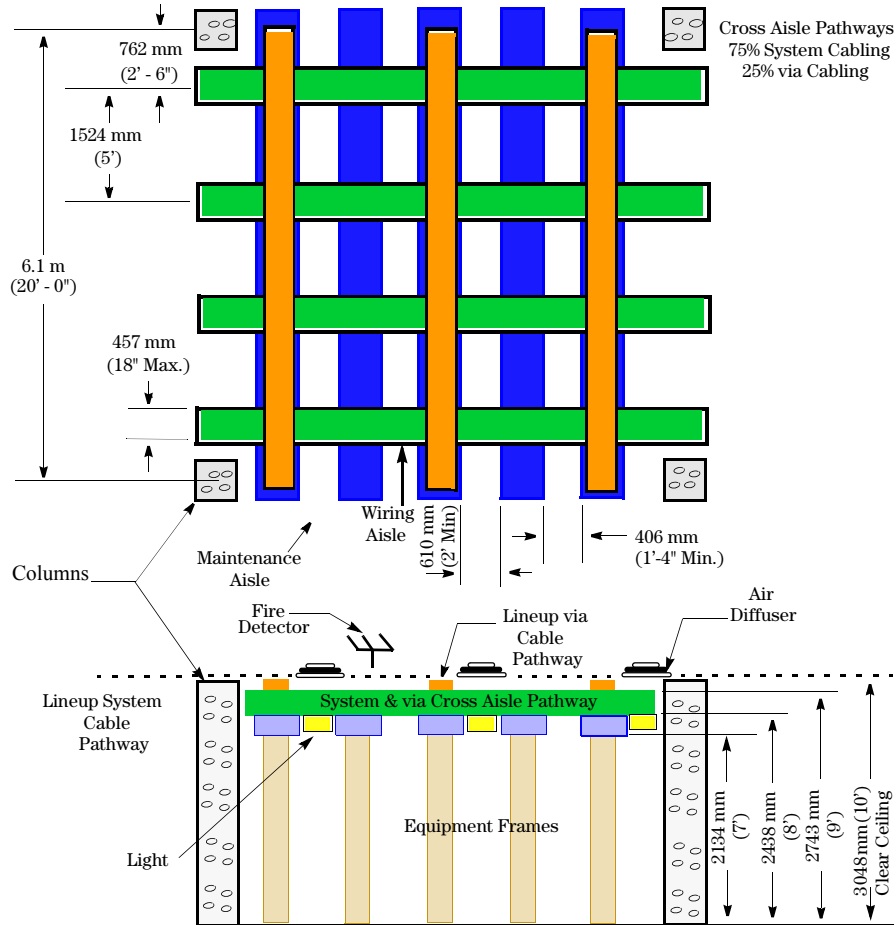

2.5.2.2 System Cable Racks

System cable racks running parallel to equipment lineups typically occupy the space in the cable pathways 2134 mm to 2438 mm (7 to 8 ft) above the floor and directly over the lineups. System cable racks running perpendicular (cross-aisle) to equipment lineups are typically 2438 mm to 2743 mm (8 to 9 ft) above the floor across the equipment area.

2.5.2.3 Via Cable Racks

Via cable racks running perpendicular (cross-aisle) to equipment lineups are typically 2438 mm to 2743 mm (*8 to 9 ft*) above the floor across the equipment area. Via cable racks running parallel to equipment lineups shall be located within the cable pathways and are typically 2743 mm to 3048 mm (*9 to 10 ft*) above the floor, directly over the lineups. The lineup via pathways should have a maximum width of 305 mm (*1 ft*). The locations of lineup via cable racks shall be designated on system floor and cabling plans.

2.5.2.4 Lights

Lights may be supported from the CDS and thus by the frames below. Lights are located over maintenance aisles and below cross-aisle cable pathways. The vertical height of the fixture above the floor should not restrict installation of new frames in a lineup, and must permit adequate frame illumination as [Section 4.7](#) describes. Lights should be located within the lighting pathways, shown in [Figure 2-11](#), in an arrangement that allows access to overhead cable racks.

2.5.3 Cable Pathways Over Distributing Frame (DF) Areas

A cable pathways plan should be prepared for each DF area. This plan should allocate the space over DFs to system and via cable racks, lights, and installer access. System cabling interconnects different parts of the same DF and includes terminating via cable. The other via cabling passes over the frame. [Figure 2-11](#) shows a typical cable pathways plan for a DF area.

2.5.4 CDS Floor Load and Support

O2-44 [37] The floor load from overhead CDSs (including lights) should not exceed 125 kg/m² (*25.6 lb/ft²*). The system CDSs are allocated 100 kg/m² (*20.5 lb/ft²*) and via CDSs are allocated 25 kg/m² (*5.1 lb/ft²*). This weight allowance may be averaged over an area not exceeding 6.1-m × 6.1-m (*20-ft × 20-ft*) square and must include all cable, rack, lights, and associated support hardware.

Figure 2-11 Typical Cable Pathways for a Distributing Frame Area

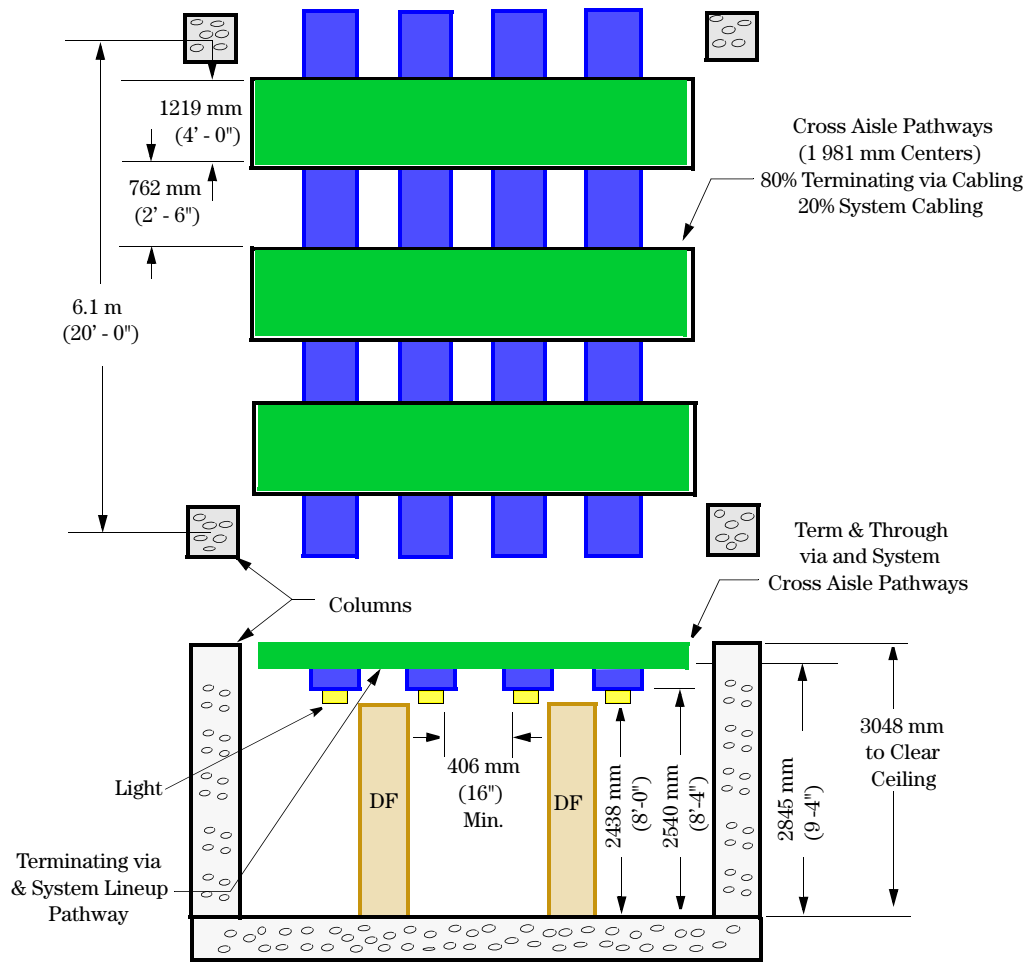

2.6 Operations Systems (OSs)

OSs assist in maintenance, operations, administration, and record-keeping. Many of the OSs use minicomputers and general-purpose computers. OSs can have either a single-site or distributed configuration. They may be located in switching and transmission equipment frame areas, in separate areas or rooms, or in both.

- R2-45 [38]** OS facilities located in equipment frame areas shall be subject to the spatial and weight requirements outlined in Section 2.1 and Section 2.2. They also shall be capable of operating in the various environments that Section 4, "Environmental Criteria," specifies.

2.7 Cable Entrance Facility (CEF)

The CEF is the interface between the network and the Outside Plant (OSP) network. The CEF provides space for the entrance, splicing, bridging, pressurization, and routing of various cables. The three types of CEFs are: above-surface, subsurface, and a combination of above-surface and subsurface, called the duplex CEF. A duplex CEF typically is used when the MDF is on an upper floor of a building. Each of these CEFs may be either enclosed by walls, partitions, etc., for fire and contamination protection, or unenclosed and thus part of the same environment as the adjacent equipment. The CEF system should be designed to adhere to the building and equipment requirements.

2.7.1 CEF Spatial Requirements

O2-46 [39] Designs for the CEF should be compatible with the spatial requirements of the network, i.e., a 3048-mm (*10-ft*) clear height for equipment and associated cabling, and 3810 mm (*12 ft, 6 in*) for the lowest building structural member.

2.7.2 CEF Loading Requirements

O2-47 [40] CEF equipment should have a maximum floor load of 700 kg/m² (*143.4 lb/ft²*). This applies to floor-supported equipment, and is determined by totaling the weight of all such equipment in the area, including cable, splice cases, and racks, and dividing by the associated floor area. The total weight may be averaged over the entire cable entrance area, including aisles and personnel work areas. The weight of all such equipment should be supported by the floor.

R2-48 [41] Wall-supported CEF equipment shall have a 375-kg/m² (*76.8-lb/ft²*) maximum weight allowance. The uniform weight allocation is the total weight of CEF equipment divided by the surface area of the wall over which the equipment is placed. The center of gravity of any such wall-supported equipment shall be 406 mm (*16 in*) or less from the surface of the wall (measured perpendicular to the wall). Otherwise, the 375-kg/m² (*76.8-lb/ft²*) weight allocation shall be proportionately decreased.

2.7.3 CEF Equipment Temperature and Humidity Requirements

R2-49 [42] Equipment installed in unenclosed above-surface CEFs that are adjacent to the network shall meet the thermal requirements specified in [Section 4.1, “Temperature, Humidity, and Altitude Criteria.”](#)

NOTE: Enclosed CEFs and unenclosed subsurface CEFs may not have permanent facilities for heating. These facilities may be subjected to low temperatures and moisture conditions outside the requirements of

Section 4.1. In an enclosed CEF, these conditions may be controlled by installing a mechanical ventilation system to provide continuous air flow from an air-conditioned part of the building.

2.8 Summary of Equipment Allocations

Table 2-2 summarizes equipment vertical space and floor load allocations.

Table 2-2 Summary of Equipment Space and Load Allocations

Equipment	Vertical Space	Floor Load
Equipment Frame Area		
<ul style="list-style-type: none"> • Frames 	Floor to 3048 mm <i>(Floor to 10 ft)</i>	560 kg/m ² <i>(114.7 lb/ft²)</i>
<ul style="list-style-type: none"> • CDS 	Floor to 3048 mm <i>(Floor to 10 ft)</i>	125 kg/m ² <i>(25.6 lb/ft²)</i>
Power Area - All equipment cabling, bus bars, lights, and installation clearances	Floor to 3048 mm <i>(Floor to 10 ft)</i>	700 kg/m ² <i>(143.4 lb/ft²)</i>
Distributing Frame Area		
<ul style="list-style-type: none"> • Equipment, cabling, lights, and installation clearances 	Floor to 2743 mm <i>(Floor to 9 ft)</i>	675 kg/m ² <i>(138.3 lb/ft²)</i>
<ul style="list-style-type: none"> • Via cabling 	2743 to 3048 mm <i>(9 to 10 ft)</i>	25 kg/m ² <i>(5.1 lb/ft²)</i>
CEF - All equipment, cable, and installation clearances	Floor to 3048 mm <i>(Floor to 10 ft)</i>	700 kg/m ² <i>(143.4 lb/ft²)</i>
Transient Loads	---	50 kg/m ² <i>(10.2 lb/ft²)</i>

3 NEBS-2000 Framework Criteria

The information in this section has been deleted in GR-63-CORE, Issue 3. This encompasses the removal of Requirements R3-1 [43] through R3-24 [66]. Please refer to ANSI T1.336-2003, Engineering Requirements for a Universal Telecom Framework for dimensional, performance, and application criteria that may be applied to framework used to support electronic equipment shelves in a telecommunications facility. The ANSI T1.336-2003 criteria may be used in place of the traditional frame dimensions of standard EIA-310-D, Cabinets, Racks, Panels, and Associated Equipment.

4 Environmental Criteria

The environmental criteria apply to all new network equipment, including associated CDSs, distributing and interconnecting frames, power equipment, critical operations support systems, and CEF equipment [see [Section 2.7, “Cable Entrance Facility \(CEF\),”](#) for CEF exceptions].

These requirements are compatible with, and at least as stringent as, the standards in **Part 1910 - Occupational Safety and Health Standards** (*Title 29 - Labor, Chapter XVII-OSHA, Department of Labor*).

[Section 5, “Environmental Test Methods,”](#) provides test methods to determine whether equipment conforms with the environmental requirements and objectives specified in this section.

Compliance to the criteria in this document is critical to evaluating the suitability of equipment for use in the telecommunication network. Hence, the equipment users require that the equipment manufacturers understand/correct known deficiencies.

-
- R4-1 [67]** The equipment manufacturer shall be responsible to perform a Root Cause Analysis (RCA) for each failure that occurs during NEBS product testing, even if subsequent retesting is successful. The RCA shall include an explanation of what failed, why it failed, and what corrective action was taken.
-
- R4-2 [68]** Corrective action to the root cause problem shall be consistent with customers' reliability/technical requirements. Identification information (e.g., manufacturing cut-in dates, serial numbers, product ID changes, order requirements, availability, etc.) for equipment incorporating the corrective action shall be provided in the RCA.
-

4.1 Temperature, Humidity, and Altitude Criteria

This section provides criteria for temperature, humidity, and altitude robustness of network equipment. The criteria cover the following:

- Transportation and storage environments
- Operating temperature and humidity environments
- Altitude
- Heat dissipation
- Equipment airflow.

4.1.1 Transportation and Storage Environmental Criteria

During transportation or in storage, equipment may be exposed to extremes in ambient temperature and humidity. The criteria in this section apply to equipment in its normal shipping container. After the equipment is exposed to the given

environment, it is returned to ambient, unpackaged and operated. Conformance is based on the equipment's ability to operate as intended when returned to ambient conditions.

4.1.1.1 Low-Temperature Exposure and Thermal Shock

R4-3 [69] The packaged equipment shall not sustain any damage or deteriorate in functional performance after it has been exposed to the environment described in [Table 4-1](#).

Table 4-1 Low-Temperature Exposure and Thermal Shock

Temperature ^a	Event	Duration/Rate of Change
23°C to -40°C (73°F to -40°F)	Temperature transition	30°C/hr (54°F/hr)
-40°C (-40°F)	Temperature soak	72 hr (minimum)
-40°C to 23°C (-40°F to 73°F)	Temperature transition	< 5 minutes

a. Any humidity (or uncontrolled humidity).

4.1.1.2 High Relative Humidity Exposure

R4-4 [71] The packaged equipment shall not sustain any damage or deteriorate in functional performance after it has been exposed to the environment described in [Table 4-2](#).

Table 4-2 High Relative Humidity Exposure

Temperature	Relative Humidity	Event	Duration/Rate of Change
23°C to 40°C (73°F to 104°F)	50% RH	Temperature transition	30°C/hr (54°F/hr)
40°C (104°F)	50% to 93% RH	Humidity transition	< 2 hr
40°C (104°F)	93% RH	Temperature/humidity soak	96 hr
40°C (104°F)	93% to 50% RH	Humidity transition	< 2 hr
40°C to 23°C (104°F to 73°F)	50% RH	Temperature transition	30°C/hr (54°F/hr)

4.1.1.3 High-Temperature Exposure and Thermal Shock

- R4-5 [70]** The packaged equipment shall not sustain any damage or deteriorate in functional performance after it has been exposed to the environment described in [Table 4-3](#).

Table 4-3 High-Temperature Exposure and Thermal Shock

Temperature ^a	Event	Duration/Rate of Change
23°C to 70°C (73°F to 158°F)	Temperature transition	30°C/hr (54°F/hr)
70°C (158°F)	Temperature soak	72 hr (minimum)
70°C to 23°C (158°F to 73°F)	Temperature transition	< 5 minutes

- a. Any humidity (or uncontrolled humidity).

4.1.2 Operating Temperature and Humidity Criteria

[Table 4-4](#) and [Figure 4-1](#) provide the normal operating temperature/humidity levels and short-term operating temperature/humidity levels in which network equipment shall operate. The test levels in this document are based on the short-term levels.

- R4-6 [72]** The equipment shall not sustain any damage or deterioration of functional performance during its operating life when operated within the conditions of [Table 4-4](#).

Note: The testing methods in [Section 5.1.2, “Operating Temperature and Relative Humidity,”](#) simulate the environment of [Table 4-4](#) and [Figure 4-1](#) for the purpose of conformance testing. However, the equipment is expected to meet the criterion **R4-6 [72]** throughout its operating life.

Table 4-4 Ambient¹ Temperature and Humidity Limits

Conditions	Limits
Temperature	
• Operating (up to 1800 m)	5°C to 40°C (41°F to 104°F)
• Short-term ²	-5°C to 50°C (23°F to 122°F)
• Short-term with fan failure	-5°C to 40°C (23°F to 104°F)
Rate of temperature change	30°C/hr (54°F/hr)
Relative Humidity	
• Operating	5% to 85%
• Short-term ²	5% to 90%, but not to exceed 0.024 kg water/kg of dry air

Notes:

1. Ambient refers to conditions at a location 1.5 m (59 in) above the floor and 400 mm (15.8 in) in front of the equipment. Frame-level products are tested to 50°C. Shelf-level products are tested to 55°C. Refer to [Section 5.1, "Temperature, Humidity, and Altitude Test Methods,"](#) for details of test conditions.
2. Short-term refers to a period of not more than 96 consecutive hours and a total of not more than 15 days in 1 year. (This refers to a total of 360 hours in any given year, but no more than 15 occurrences during that 1-year period.)

Figure 4-1 Ambient Temperature and Humidity Limits

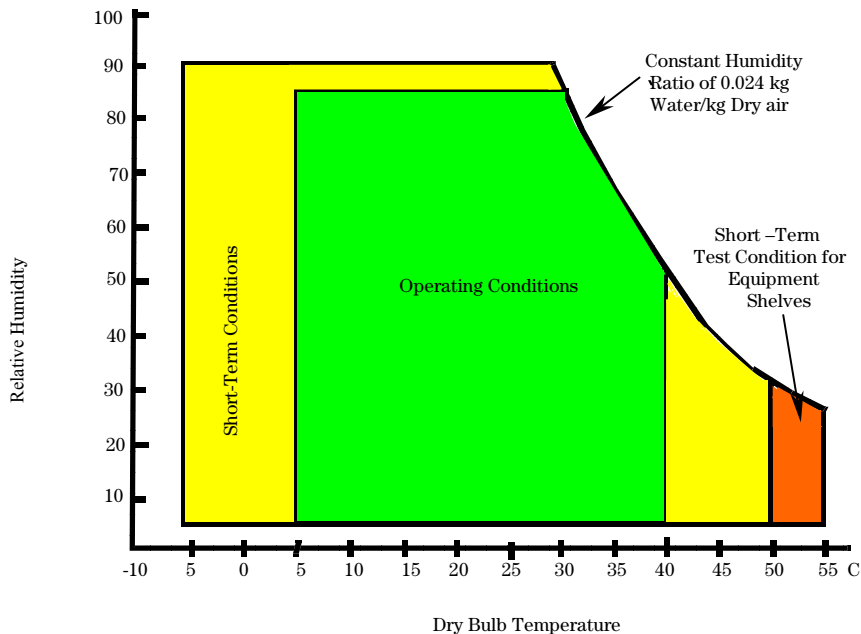

R4-7 [73] This requirement has been deleted per Issue 3.

4.1.3 Altitude

R4-8 [74] All equipment shall be functional when installed at elevations between 60 m (197 ft) below sea level and 1800 m (6000 ft) above sea level at aisle-ambient temperatures of 40°C.

R4-9 [136] All equipment shall be functional when installed at elevations between 1800 m (6000 ft) and 4000 m (13,000 ft) above sea level, at aisle-ambient temperatures of 30°C.

At elevations greater than 1800 m above sea level, the cooling capacity of ambient air is reduced due to its reduced density. It may be necessary to work with the purchaser to provide adequate cooling.

R4-10 [75] The manufacturer shall provide special requirements for installations above 1800 m (6000 ft) in the product documentation, if needed.

O4-11 [137] All equipment should be functional when installed at elevations between 60 m (197 ft) below sea level and 1800 m (6000 ft) above sea level at aisle-ambient temperatures of 50°C.

O4-12 [76] All equipment should be functional when installed at elevations between 1800 m (6000 ft) and 4000 m (13,000 ft) above sea level, at aisle-ambient temperatures of 40°C.

4.1.4 Temperature Margin Evaluation

The temperature margin evaluation is intended to determine the system response to temperatures above the short-term extreme. This is not intended to change design criteria or operating temperature range. It is intended only to provide additional information.

R4-13 [153] Equipment response to temperatures up to 10°C above the short-term high temperature extreme of [Table 4-4, “Ambient¹ Temperature and Humidity Limits,”](#) shall be determined. Report the threshold temperature for deterioration of functional performance and/or equipment shutdown.

Testing in excess of 10°C above the short-term limits is not necessary.

4.1.5 Fan Cooled Equipment Criteria

The criteria in this section are intended to ensure that fan cooled equipment operate as intended and can be maintained efficiently. It is important that equipment will continue to function normally with a single fan or blower failure over the entire long-term operating temperature range. This will permit deployed equipment to continue to operate until a fan replacement can be performed.

- R4-14 [154]** Equipment cooled by forced convection shall not sustain damage or deterioration of functional performance when operated with any single fan failure at a 40°C aisle ambient for a short-term of up to 96 hours per [Table 4-4, “Ambient¹ Temperature and Humidity Limits.”](#)

Hardware redundancy may be used to assure that equipment does not deteriorate in functional performance during a fan failure.

- R4-15 [155]** Equipment cooled by forced convection shall have provisions for remote alarm notification of a fan failure.

- O4-16 [156]** Equipment cooled by forced convection should be designed and constructed such that any fan or cooling unit replacement can be performed with no service interruption.

Hardware redundancy may be used to assure that cooling unit replacement can be performed with no service interruption.

- R4-17 [157]** The replacement procedure for fans and cooling units shall be included in the product documentation.

- R4-18 [158]** When a fan or cooling unit replacement requires service interruption, the estimated time of replacement by a skilled technician shall be reported.

4.1.6 Heat Dissipation

Management of heat dissipated by telecommunications equipment is a major challenge for service providers. Crucial to this management is accurate reporting of expected equipment heat loads. The criteria of this section are based on the cooling capacities of traditional network facilities. For additional information on equipment and room cooling methods, refer to **GR-3028-CORE**, *Thermal Management in Telecommunication Central Offices: Thermal GR-3028*.

- R4-19 [77]** The maximum heat release and method of cooling (e.g., natural convection, forced-air fans) shall be documented for all equipment. For floor mounted equipment, document the heat release in Watts, as well as W/m² or W/ft² of floor

area. For equipment shelves, document the heat release in Watts as well as W/m^2 per meter or W/ft^2 per foot of frame vertical height used.

Data shall be documented for each individual chassis for chassis level products, or each frame, each building bay, and for the entire system for larger systems as applicable. If the multiframe system is provided in alternate floor plans, such as back-to-back with no wiring aisle, then data for those configurations must also be documented.

The floor area used to calculate the heat dissipation always includes the associated aisles. In the case of an individual frame or shelf, the area is that of a rectangle outlined by the frame sides and the center lines of the standard front (maintenance) aisle (minimum 760 mm or 30 inches) and rear (wiring) aisle (minimum 600 mm or 24 inches). For a system of equipment frames, the floor area includes maintenance aisles, wiring aisles, equipment footprint, main/cross aisles between lineups, open area building column lines, and any adjacent perimeter or access aisles that do not have separate partitions.

-
- 04-20 [78]** Equipment heat release should not exceed the values presented in [Table 4-5](#), “[Equipment Area Heat Release Objective](#).” Heat release greater than these objectives must be clearly identified in product documentation along with a note indicating that special equipment room cooling may be required. The heat release objectives for an individual frame are based upon overall system heat release that does not exceed the system values [Table 4-5](#) provides.
-

To cope with high heat release, aisle spacings may be increased and high heat-dissipating equipment may be located adjacent to equipment generating less heat. Refer to **GR-3028-CORE**.

Table 4-5 Equipment Area Heat Release Objective

Individual Frame	
Natural Convection	1450 W/m ² (134.7 W/ft ²)
Forced-Air Fans	1950 W/m ² (181.2 W/ft ²)
Multi-Frame	
Entire System	860 W/m ² (79.9 W/ft ²) *
Any 6.1-m × 6.1-m (20-ft × 20-ft) square area within a larger system	1075 W/m ² (99.9 W/ft ²) *
Shelf	
Natural Convection	740 W/m ² per meter (20.9 W/ft ² /ft) of vertical frame space the equipment uses.
Forced-Air Fans	995 W/m ² per meter (27.9 W/ft ² /ft) of vertical frame space the equipment uses.

* Systems totally comprised of forced-air cooled equipment may increase these levels to 1075 W/m² (99.9 W/ft²) and 1290 W/m² (119.8 W/ft²).

4.1.7 Surface Temperature

The criteria and methodology of this document are based on the draft of the Alliance for Telecommunications Industry Solutions (ATIS) Standard, *Equipment Surface Temperature*, **ATIS-060004**.

O4-21 [79] It is an objective that equipment surfaces that face aisles or surfaces where normal maintenance functions are anticipated shall not exceed 48°C (118°F) when the equipment is operating in a room with an ambient air temperature of 23°C (73°F). Passive equipment, wherein no heat is generated, are exempt from testing.

R4-22 [159] It is a requirement that equipment surfaces that face aisles or surfaces where normal maintenance functions are anticipated shall be in conformance to the temperature limits established in **Table 4-6, "Temperature Limits of Touchable Surfaces,"** when the equipment is operating in a room with an ambient air temperature of 23°C (73°F). Passive equipment, wherein no heat is generated, is exempt from testing.

Surfaces protected from normal personnel access are not subject to temperature limits described. These protected surfaces are as follows:

- Equipment side surfaces shielded by cable bundles, cabinet side panels, and/or rack uprights,
- Top and bottom panels isolated by equipment vertically stacked above/below,

- Protective shields, backplanes inboard of cables/rear, or
- Internal circuit boards and board components.

The surfaces to which personnel may be exposed are typically equipment parts that are contacted during normal function or servicing of the equipment. These normally include:

- Equipment surfaces that the hands, arms, or face of the personnel may contact.
- Equipment surfaces that could cause burns or result in unexpected reaction of personnel.
- Equipment surfaces such as handles, circuit pack dislodging levers, and retaining hardware that require personnel to have prolonged exposure.

Surfaces that incur prolonged exposure shall have lower temperature limits than surfaces with shorter exposure time.

The stated temperature limits do not include the direct exhaust air discharge temperatures of equipment. However, if applicable equipment surface temperatures should become elevated by the heated exhaust airflow, the temperature limits would apply to those surfaces.

Table 4-6 Temperature Limits of Touchable Surfaces

Materials	Permitted Temperature (°C) as a Function of Exposure Times	
	Unintentional Contact or Parts Held for Short Periods in Normal Use ¹	Prolonged Use ²
Metals ³	55	48
Nonmetals	70	48

Notes:

1. Parts held in normal use are expected to be held up to 10 seconds. Examples may include extractor tabs, handles, knobs, and grips. Examples may also include surfaces handled during maintenance, repair, or upgrade.
2. Prolonged use is anywhere between 10 seconds and 10 minutes. Examples may include surfaces handled during more extensive maintenance and repair procedures.
3. Metals may be coated, uncoated, plated and/or have a conversion coating. Conversion coatings are assumed to be thermally conductive.

4.1.8 Equipment Airflow

The most common way to cool modern telecommunications equipment is using fans to create forced-convection cooling. The location of air inlets and exhausts in equipment can affect the efficiency of heat removal in both equipment and the room. For this reason, a standard airflow pattern is desirable.

Service providers usually rely on equipment environments with ventilation cooling air provided from overhead ducts and diffusers. An estimated 95% of the equipment buildings operated by service providers utilize this room cooling scheme. In

addition, most environments maintain cooler front (maintenance) aisles and warmer rear (wiring) aisles. Equipment airflow from the front-bottom to the top-rear work well in this environment. **GR-3028-CORE** classifies the location of equipment air-intake and exhaust on network equipment, and provides the basis for the following criteria.

O4-23 [160] Equipment cooled by forced convection should be constructed with one of the following airflow schemes:

- Bottom-front to top-rear airflow (EC class F1-R3) (preferred)
- Bottom-front to top (EC class F1-T)
- Mid-front to mid-rear (EC class F2-R2)
- Mid-front to top-rear (EC class F2-R3)
- Mid-front to top (EC class F2-T).

Figure 4-2 Profile View of Conforming Equipment Airflow Schemes Dashed Method Is Preferred

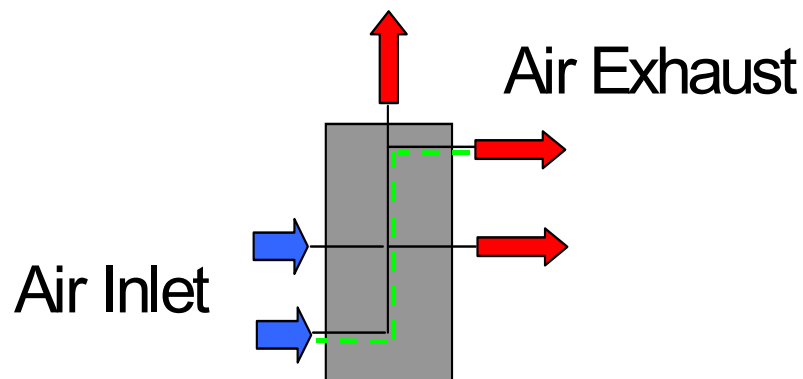

O4-24 [161] The following equipment airflow schemes should **not** be used:

- Bottom exhaust (EC class X-B)
- Front exhaust (EC class X-FX)
- Side exhaust (EC class X-SRX or X-SLX).

4.2 Fire Resistance

This section provides minimum fire-resistance requirements for new equipment systems and for additions to, or retrofit of, existing equipment systems. The requirements apply to the primary supplier and Original Equipment Manufacturer (OEM) of subassemblies that constitute an equipment system when interconnected. It is expected that all equipment uses properly sized and electrically protected circuitry.

4.2.1 Fire-Resistance Rationale

The following criteria are set to help minimize the occurrence of fires in equipment and cabling and to help prevent fires from spreading.

- **Equipment Assemblies** — Equipment assembly fire tests are performed in accordance with [Section 4.2.2, “Equipment Assembly Fire Tests,”](#) and the procedures noted in [Section 5.2, “Fire Test Methods.”](#) These tests are used to characterize the fire propagation hazard, and to demonstrate that an equipment assembly fire does not spread beyond the equipment under test.
- **Material Selection** — Materials, electrical components, and equipment cables and wires (provided by the equipment manufacturer) that meet the fire-resistance requirements in [Section 4.2.3, “Use of Fire-Resistant Materials, Components, Wiring, and Cable,”](#) help minimize the ignition of fires in equipment.
- **Cabling Assemblies** — Wire and cable that run horizontally or vertically in equipment space are tested based on the cable’s or wire’s application as defined in the standard fire-test methods specified in [Section 4.2.3.](#) These requirements help minimize spread of fire within the building.

4.2.2 Equipment Assembly Fire Tests

Equipment assemblies shall be tested according to the procedures of [Section 5.2, “Fire Test Methods,”](#) and [ANSI T1.319-2002, *Equipment Assemblies - Fire Propagation Risk Assessment Criteria*,](#) to characterize the fire propagation hazard and to determine whether they satisfy the appropriate firespread criteria. Frame-level equipment is assessed against the criteria of [Section 4.2.2.1, “Frame-Level Fire-Resistance Criteria,”](#) and [Section 4.2.2.3, “Smoke and Self-Extinguishment Criteria.”](#) Products that are primarily supplied as shelf units are assessed against the criteria of [Section 4.2.2.2](#) and [Section 4.2.2.3.](#) The criteria set evaluated depends on the equipment configuration. An equipment assembly is evaluated based on only one of these criteria sets (not both), based on the maximum configuration available.

Conformance is based on a test sample that (a) represents a potential worst-case condition for firespread, considering fuel load, air flow, and physical structure, (b) provides a physical configuration of the assembly constituents, including OEM units, and all interconnect wire and cable, within the test assembly that represents the generic equipment being analyzed for fire resistance, and (c) is configured as it would be for use in the network.

Equipment that contains multiple compartments should be analyzed by performing tests in each individual compartment type. An example of this type of equipment would be a chassis containing power supplies, disk drives, and vertically oriented circuit boards.

The equipment under test is not required to operate functionally. However, all internal equipment fans must be operational and powered. If the fans are variable speed, fans shall be powered via the normal powering path, including any fan speed control circuitry, from the point where power is applied to the assembly during normal operation. Sufficient power shall be supplied to the assembly to allow the fans to operate as intended. If the circuit card removed for fire testing is the power supply that operates the EUT, and no other power supply operates the fans, the fans shall not be powered.

Refer to **ANSI T1.319-2002** and [Section 5.2](#) of this GR for more details on testing, including sample configuration, burner location selection, and fan operation.

NOTE: In some cases, it may be necessary to test equipment categorized as exempt by **ANSI T1.319-2002**, Section 4.3. Such tests may be used to confirm that products use fire-resistant materials and construction as assumed in the ANSI standard and present a low fire-propagation risk.

4.2.2.1 Frame-Level Fire-Resistance Criteria

A. Firespread Criteria

R4-25 [80] This requirement has been deleted per Issue 3.

R4-26 [81] When tested following the procedures of **ANSI T1.319-2002** and the modifications of [Section 5.2](#) of this GR, fire shall not spread beyond the confines of the equipment assembly being tested. In accordance with **ANSI T1.319-2002**, the fire shall be judged to have spread beyond the equipment under test if **any** of the following occur:

- Sustain ignition to an adjacent equipment enclosure or printed circuit board material of an adjacent equipment shelf
- Ignition of the Frame Level Ignition Indicator Module (FLIIM).

R4-27 [162] When tested following the procedures of **ANSI T1.319-2002** and the modifications of [Section 5.2](#) of this GR, the equipment shall not demonstrate excessive surface burning or external flaming. The equipment shall be judged to have excessive surface burning or external flaming if the following occurs:

- Flames (other than flames from the *methane* line burner) in excess of 50 mm in any dimension and extending beyond the top or bottom of the equipment under test for 30 seconds or more, after 170 seconds from the start of the line burner profile.

- Flames (other than flames from the *methane* line burner) in excess of 50 mm in any dimension extending beyond any confines of the front, rear or sides of the equipment under test continuously for 30 seconds or more.

The presence of methane line burner flames outside the equipment does not constitute excessive surface burning or external flaming. Obvious signs of methane line burner flames include blue color, low smoke, and a resultant lack of internal charring.

B. Fire Propagation Hazard Characterization

- R4-28 [82]** The fire propagation hazard shall be characterized by measuring and recording the rate of heat release of the equipment fire as tested by the methods of [Section 5.2, “Fire Test Methods.”](#)
- O4-29 [83]** The peak rate of heat release measured should not exceed 150 kW at any time during the test.
- O4-30 [84]** The average rate of heat release should not exceed 100 kW over any 30-minute period during the test.

4.2.2.2 Shelf-Level Fire-Resistance Criteria

A. Firespread Criteria

- R4-31 [85]** This requirement has been deleted per Issue 3.
- R4-32 [86]** When tested following the procedures of **ANSI T1.319-2002** and the modifications of [Section 5.2](#) of this GR, fire shall not spread beyond the confines of the equipment assembly being tested. In accordance with **ANSI T1.319-2002**, the fire shall be judged to have spread beyond the equipment under test if the following occurs:
- Ignition of the Shelf Level Ignition Indicator Module (SLIIM).
- R4-33 [163]** When tested following the procedures of **ANSI T1.319-2002** and the modifications of [Section 5.2](#) of this GR, the equipment shall not demonstrate excessive surface burning or external flaming. The equipment shall be judged to have excessive surface burning or external flaming if any of the following occur:
- Flames (other than flames from the *methane* line burner) in excess of 50 mm in any dimension and extending beyond the top or bottom of the equipment under test for 30 seconds or more, after 170 seconds from the start of the line burner profile.

- Flames (other than flames from the *methane* line burner) in excess of 50 mm in any dimension extending beyond any confines of the front, rear or sides of the equipment under test continuously for 30 seconds or more.

The presence of methane line burner flames outside the equipment does not constitute excessive surface burning or external flaming. Obvious signs of methane line burner flames include blue color, low smoke, and a resultant lack of internal charring.

B. Fire Propagation Hazard Characterization

- R4-34** [87] The fire propagation hazard shall be characterized by measuring and recording the rate of heat release of the equipment fire, as tested by the methods of [Section 5.2, "Fire Test Methods."](#)
- O4-35** [88] The peak rate of heat release measured should not exceed 50 kW at any time during the test.
- O4-36** [89] The average rate of heat release should not exceed 35 kW during any 15-minute period during the test.

4.2.2.3 Smoke and Self-Extinguishment Criteria

The following smoke and self-extinguishment criteria help to minimize smoke hazards from network equipment fires that may broadly impact large areas of equipment rooms.

- O4-37** [164] At 4 minutes and 30 seconds into the test, after the conclusion of the methane ignition line burn, the components in the equipment assembly should show evidence of beginning to self-extinguish.
- O4-38** [165] At 10 minutes into the test, there should be a significant flame reduction and a reduction in the visible smoke from the equipment assembly as determined by visual observations and supported by the video record and analytic smoke measurements.
- R4-39** [166] At 15 minutes into the test, flames shall be extinguished.
- O4-40** [167] At 15 minutes into the test, there should be no more than minimal wisps of smoke from the equipment assembly as determined by visible observations and supported by the video record and analytic smoke measurements.
- R4-41** [168] At 20 minutes into the test, there shall be no visible smoke from the equipment assembly as determined by visible observations and supported by the video record and analytic smoke measurements.

4.2.3 Use of Fire-Resistant Materials, Components, Wiring, and Cable

4.2.3.1 Material/Components Fire-Resistance Criteria

R4-42 [90] All materials, components, and interconnect wire and cable used within equipment assemblies shall meet the requirements of Section 4.1 of **ANSI T1.307-2003, *Fire-Resistance Criteria - Ignitability Requirements for Equipment Assemblies, Ancillary Non-Metallic Apparatus, and Fire Spread Requirements for Wire and Cable.***

The requirements contained in Section 4.1 of **ANSI T1.307-2003** are summarized below.

A. Mechanical Components (Non-Electrically Energizable)

R4-43 [91] Mechanical components (examples include circuit boards, backplanes, connectors, and plastic covers and handles) shall be either:

- Rated SC 0, SC 1, SC-TC 0 or SC-TC 1, or
- Formed of materials that, in the minimum thickness as used in the component, are rated UL 94 V-0 as determined by **ANSI/UL 94-1996, *Test for flammability of plastic materials for parts in devices and appliances,*** or
- Formed of materials that, in the minimum thickness as used in the component, are rated UL 94 V-1 and have an oxygen index of 28% or greater as determined by **ASTM D2863-00, *Standard Test Method for Measuring the Minimum Oxygen Concentration to Support Candle-Like Combustion of Plastics (Oxygen Index),*** or
- Conforming to the needle flame test of **ANSI T1.307-2003** (Section 5.1), or
- Conforming to the in-situ needle flame test of **ANSI T1.307-2003** (Section 5.2), or
- Conforming to the Telcordia needle flame test of [Section 5.2.3.1](#) of this GR, or
- Conforming to the Telcordia in-situ needle flame test of [Section 5.2.3.2](#) of this GR.

Discrete structural components with overall dimensions of 6.3 mm (1/4 inch) × 6.3 mm (1/4 inch) × 6.3 mm (1/4 inch) or less, or constituting a fuel load of 1 gram (0.035 oz.) or less are exempt from the requirements of **R4-43 [91]**. If such components are grouped in close proximity and their total mass exceeds 1 gram (0.035 oz.) they shall comply with **R4-44 [92]**.

R4-44 [92] Small discrete structural components, grouped in close proximity, as described in the second paragraph of **R4-43 [91]**, shall be tested to the needle flame test, as described in **ANSI T1.307-2003** (Section 5.2), or the Telcordia needle flame test of [Section 5.2.3](#). The ignition of one component by the test flame shall not ignite any adjacent component.

R4-45 [93] Foamed polymers shall meet the HF-1 requirements of **ANSI/UL 94-1996**.

NOTE: Foamed polymer air filter assemblies must also meet the firespread requirements of **Section 4.5, "Airborne Contaminants."**

R4-46 [94] This requirement has been deleted per Issue 2.

R4-47 [95] Insulating tapes shall meet the flammability requirements of **UL 510-2005, *Insulating Tape***.

R4-48 [96] Sleeving and tubing flammability shall meet the VW-1 requirements of **ANSI/UL 1441-1995, *Coated Electrical Sleeving***.

B. Electronic Components (Electrically Energizable)

R4-49 [97] Discrete electronic components shall be either:

- Conforming to the needle flame test of **ANSI T1.307-2003**, Section 5.1, or
- Conforming to the in-situ needle flame test of **ANSI T1.307-2003**, Section 5.2, or
- Conforming to the Telcordia needle flame test of **Section 5.2.3.1** of this GR, or
- Conforming to the Telcordia in-situ needle flame test of **Section 5.2.3.2** of this GR, or
- Be rated SC 0, SC 1, SC-TC 0 or SC-TC 1, or
- Formed of materials that, in the minimum thickness as used in the component, are rated UL 94 V-0 as determined by **ANSI/UL 94-1996**, or
- Formed of materials that, in the minimum thickness as used in the component, are rated UL 94 V-1 and have an oxygen index of 28% or greater as determined by **ASTM D2863-2000**.

C. Interconnect Wire

Interconnect wire refers to individual wires and cables that are totally contained within the equipment assembly. Any wire or cable exiting the frame of an equipment assembly shall meet the requirements of **Section 4.2.3.2, "Cable Distribution Assemblies."**

R4-50 [98] Interconnect wire shall satisfy the VW-1 requirements contained in **ANSI/UL 1581-2001, *Reference standard for electrical wires, cables, and flexible cords***.

O4-51 [99] This objective has been deleted per Issue 3.

4.2.3.2 Cable Distribution Assemblies

Firespread requirements for cable distribution assemblies and all wire and cable for use between equipment frames are specified in **ANSI T1.307-2003**, Section 4.2. These requirements are summarized below.

R4-52 [100] This requirement has been deleted per Issue 3. It is incorporated into other Section 4 requirements of this GR.

A. Wire and Cable in Duct or Plenum Spaces

R4-53 [101] Communications wiring used in air-handling ducts and plenums shall have a maximum flame spread of 1.5 m, a maximum peak optical smoke density smoke value of 0.5, and a maximum average optical density value of 0.15 when tested in accordance with **ANSI/NFPA 262-2002**, *Test for fire and smoke characteristics of wires and cables*. Power wire and cable used in air handling ducts and plenums shall comply with Article 300-22 of **ANSI/NFPA 70-2002**, *National electrical code*.

B. Wire and Cable in Riser Shafts

R4-54 [102] Wire and cable used in riser shafts shall satisfy the flammability requirements of **ANSI/UL 1666-2000**, *Test for flame propagation height of electrical and optical-fiber cables installed vertically in shafts*. Wire and cable suitable for use in duct or plenum spaces conform to this requirement.

C. Wire and Cable in Other Spaces

R4-55 [103] Communication and power wire and cables running either horizontally or vertically in other spaces including dedicated cable pathways or cross-connect equipment, shall meet one of the following requirements:

- **UL 1685 -1997**, *Vertical-tray fire-propagation and smoke-release test for electrical and optical-fiber cable*, or
- **CAN/CS-C22.2 No. 0.3-01**, *Test methods for electrical wires and cables*, or
- **ANSI/IEEE 1202-1991**, *Flame testing of cables for use in cable tray in industrial and commercial occupancies*.

Wire and cable suitable for use in duct or plenum spaces or riser shafts conform to this requirement.

The requirements of this section do not apply to compartmented Cable Entrance Facilities (CEFs). However, cables entering the CEF from the outside should be spliced to cables that conform to these requirements, as appropriate, and as close as practical to the point at which cables enter the CEF.

D. Limited Smoke Wire and Cable

- O4-56 [104]** Communication, power, and riser wire and cable should satisfy the requirements for smoke emission levels of **UL 1685-1997**, *Vertical-tray fire-propagation and smoke-release test for electrical and optical-fiber cable*.

E. AC-Powered Wiring and Fittings

- R4-57 [105]** All ac-powered wiring and fittings in equipment shall meet the flammability requirements referenced by the National Electrical Code (NEC) for their specific use in the equipment.

4.2.4 Smoke Corrosivity

- O4-58 [106]** This objective has been deleted per Issue 3.

4.2.4.1 Optical Fiber Cable Trays and Raceways

Firespread requirements for optical fiber cable trays and raceways for use between equipment frames are specified in **ANSI T1.307-2003**, Section 4.3. These requirements are summarized below.

A. Optical Fiber Cable Tray/Raceway in Duct or Plenum Spaces

- R4-59 [169]** Optical fiber cable tray/raceway used in air handling ducts and plenums shall have a maximum flame spread of 5 ft (1.52 m), a maximum peak optical smoke density smoke value of 0.5, and a maximum average optical density value of 0.15 when tested in accordance with the Test for Flame Propagation and Smoke Density Values (Plenum) of **UL 2024A-2002**, *Outline of Investigation for Optical Fiber Cable Routing Assemblies*.

B. Optical Fiber Cable Tray/Raceway in Riser Shafts

- R4-60 [170]** Optical fiber cable tray/raceway used in riser shafts shall satisfy the flammability requirements of the Test for Flame Propagation (Riser) of **UL 2024A-2002**, *Outline of Investigation for Optical Fiber Cable Routing Assemblies*.

C. Optical Fiber Cable Tray/Raceway in Other Spaces

- R4-61 [171]** Optical fiber cable tray/raceway used in spaces other than duct, plenum or riser spaces shall comply with the Vertical Tray Flame Test (General) of **UL 2024A-2002**, *Outline of Investigation for Optical Fiber Cable Routing Assemblies*.

D. Ignitability Requirements for Ancillary Materials

Requirements for the fire resistance of exposed nonmetallic apparatus such as framework components, covers, viewing panels, etc., are specified in **ANSI T1.307-2003**, Section 4.4. These requirements are summarized below.

-
- R4-62 [172]** Products having an exposed surface area $< 1 \text{ ft}^2$ (0.09 m^2) shall be formed from materials having a fire-resistance characteristic equivalent to or better than UL 94 V-0 as determined by **ANSI/UL 94-1996**.
-
- R4-63 [173]** Products having an exposed surface area $\geq 1 \text{ ft}^2$ (0.09 m^2) to 10 ft^2 (0.93 m^2) shall be formed from materials having a fire-resistance characteristic equivalent to or better than UL-94 5V as determined by **ANSI/UL 94-1996**.
-
- R4-64 [174]** Products having an exposed surface area $> 10 \text{ ft}^2$ shall be formed from materials having a fire-resistance characteristic equivalent to or better than UL-94 5VA as determined by **ANSI/UL 94-1996**, and shall have a flame-spread rating of < 200 .
-

4.3 Equipment Handling Criteria

Network equipment shall be capable of being handled without becoming damaged. This section provides handling criteria that may be required of the supplier.

The criteria are intended to envelope the damage potential that the equipment may experience during transportation and installation. Shock criteria expressed as drop heights for various network equipment weight classes are specified below.

[Section 5.3, "Handling Test Methods,"](#) presents test methods for analyzing equipment according to these criteria. The criteria for unpackaged equipment represent the handling shocks incurred by equipment during uncrating and installation in the network. These criteria are considered to be the minimum standard for unpackaged equipment.

4.3.1 Packaged Equipment Shock Criteria

The criteria applicable to containers (e.g., packaged equipment) are based on the mass of the container, and whether the container is provided with a skid or pallet.

The applicable criteria for the container are based on the following:

- **Category A**
 - Gross mass $< 100 \text{ kg}$ (220.5 lb).
- **Category B**
 - Gross mass $\geq 100 \text{ kg}$ (220.5 lb), or
 - The container is palletized.

Both **Category A** and **B** containers are subjected to free-fall drops. The shock inputs are applied to the exteriors of container. The drop heights are derived from **ETSI EN 300 019-2-2**, *Equipment Engineering (EE); Environmental conditions and environmental tests for telecommunications equipment; Part 2-2: Specification of environmental tests; Transportation, Test Specification T2.3 - Public Transportation*.

4.3.1.1 Category A Containers

The criterion that follows applies to **Category A** containers.

- R4-65 [107]** The packaged equipment **shall not** sustain any physical damage or deteriorate in functional performance when subjected to free-fall shock levels of [Table 4-7](#).

Table 4-7 Category A Container Packaged Equipment Shock Criteria

Mass (kg)	Drop Height (mm)	Handling Mode
< 10 (< 22.1 lb)	1000 (39.4 in)	One person throwing
< 15 (< 33.1lb)	1000 (39.4 in)	One person carrying
< 20 (< 44.1 lb)	800 (31.5 in)	Two persons carrying
< 30 (< 66.2 lb)	600 (23.6 in)	
< 40 (< 88.2 lb)	500 (19.7 in)	
< 50 (< 110.3 lb)	400 (15.7 in)	
< 100 (< 220.5 lb)	300 (11.8 in)	

4.3.1.2 Category B Containers

The criterion below apply to **Category B** containers.

- R4-66 [108]** The packaged equipment **shall not** sustain any physical damage or deteriorate in functional performance when subjected to free-fall shock levels of [Table 4-8](#).

Table 4-8 Category B Container Packaged Equipment Shock Criteria

Mass (kg)	Drop Height (mm)
Any	100 (3.9 in)

4.3.2 Unpackaged Equipment Shock Criteria

The criterion that follows apply to unpackaged equipment.

R4-67 [109] The unpackaged equipment **shall not** sustain any physical damage or deteriorate in functional performance when subjected to applicable shock levels of [Table 4-9](#).

Minor cosmetic damage, such as scratches, dings, and nicks, do not necessarily constitute nonconformance.

Table 4-9 Unpackaged Equipment Shock Criteria

Mass (kg)	Drop Height (mm)
0 to < 10 (0 - 22 lb)	100 (3.9 in)
10 to < 25 (22 - 55.1 lb)	75 (3 in)
25 to < 50 (55.1 - 110.2 lb)	50 (2 in)
50 or greater (110.2 lb)	25 (1 in)

4.4 Earthquake, Office Vibration, and Transportation Vibration

This section provides the generic criteria for earthquake, office vibration, and transportation vibration for network equipment.

4.4.1 Earthquake Environment and Criteria

4.4.1.1 Earthquake Environment

During an earthquake, telecommunications equipment is subjected to motions that can over-stress equipment framework, circuit boards, and connectors. The amount of motion and resulting stress depends on the structural characteristics of the building and framework in which the equipment is contained, and the severity of the earthquake. [Figure 4-3](#) shows the map of earthquake risk zones. Zone 4 corresponds to the highest risk areas, Zone 3 the next highest, and so on. Geographic areas designated as Zone 0 present no substantial earthquake risk. Equipment to be used in earthquake risk Zones 1 through 4 shall be tested to determine the equipment's ability to withstand earthquakes. No earthquake requirements are provided for Zone 0. [Table 4-10](#) correlates the earthquake risk zone with the expected Richter Magnitude, Modified Mercalli Index, and the expected ground and building accelerations.

Table 4-10 Correlation of Earthquake Risks

Earthquake Risk Zone	Richter Magnitude	Modified Mercalli Index (MMI)	Low Frequency Ground Acceleration (g's)	Low Frequency Upper Building Floor Acceleration (g's)
0	< 4.3	V	< 0.05	< 0.2
1	4.3 - 5.7	V - VII	0.05 - 0.1	0.2 - 0.3
2	5.7 - 6.3	VII - VIII	0.1 - 0.2	0.3 - 0.4
3	6.3 - 7.0	VIII - IX	0.2 - 0.4	0.4 - 0.6
4	7.0 - 8.3	IX - XII	0.4 - 0.8	0.6 - 1.0

NOTE: For each risk zone, there is a 90% likelihood that an earthquake event of this severity will not be exceeded over a 50-year period.

Section 5.4.1 details earthquake test methods. A frame-level test configuration is used for network equipment supplied with a framework. A shelf-level configuration is used for equipment supplied as a shelf to be installed in framework by the purchaser. A method is also provided for equipment intended to be wall-mounted. The tested equipment is expected to meet physical and functional performance requirements. All framework and concrete expansion anchors used in network facilities are expected to meet the additional criteria of Section 4.4.2.

Figure 4-3 Telcordia Earthquake Zone Map

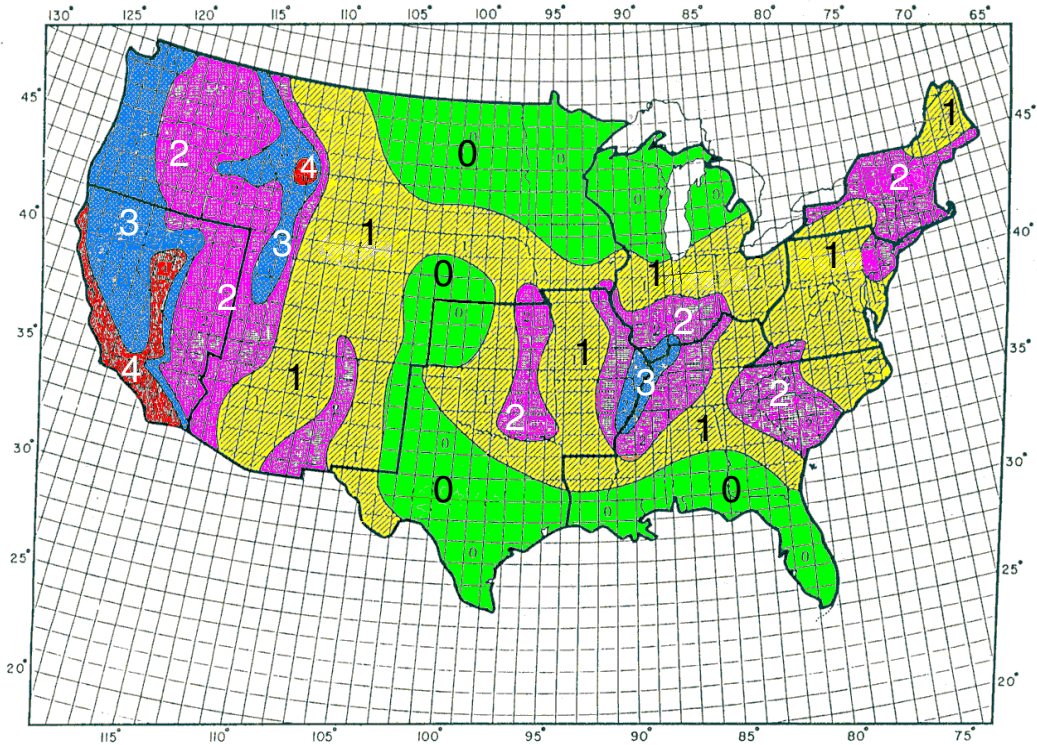

4.4.1.2 Physical Performance Criteria

Permanent structural damage is defined to be deformation of any load-bearing element of the equipment being tested, or any connection failure. Typical examples of permanent structural damage are bent or buckled uprights, deformed bases, cracks, and failed anchors or fastening hardware.

Mechanical damage is defined to be any dislocation or separation of components. Examples of mechanical damage are disengaged circuit cards and modules, and opened (including partially) doors, drawers, or covers.

R4-68 [110] All equipment shall be constructed to sustain the waveform testing of [Section 5.4.1, “Earthquake Test Methods,”](#) without permanent structural or mechanical damage.

During frame-level testing, the physical performance of the equipment shelves, framework, and fastening hardware are considered. Permanent structural or mechanical damage of any of these elements constitutes a test failure. During shelf-level and wall-mounted testing, only the equipment shelf’s physical performance is considered. (Permanent structural or mechanical damage of the framework or its fastening hardware would not constitute a failure, but may invalidate the test.)

Repairs or replacements that can be made without interrupting service are acceptable. An example of such a repair is an anchor that has loosened, but can be retightened.

R4-69 [111] Frame-level equipment shall be constructed so that during the waveform testing of [Section 5.4.1, “Earthquake Test Methods,”](#) the maximum single-amplitude deflection at the top of the framework, relative to the base, does not exceed 75 mm (3 in).

R4-70 [112] Frame-level equipment shall have a natural mechanical frequency greater than 2.0 Hz as determined by the swept sine survey of [Section 5.4.1, “Earthquake Test Methods.”](#)

O4-71 [113] Frame-level equipment should have a natural mechanical frequency greater than 6.0 Hz as determined by the swept sine survey of [Section 5.4.1, “Earthquake Test Methods.”](#)

4.4.1.3 Functional Performance

R4-72 [114] All equipment shall be constructed to meet applicable functionality requirements **immediately before and after** each axis of waveform testing of [Section 5.4.1, “Earthquake Test Methods.”](#) The equipment shall sustain operation without replacement of components, manual rebooting, or human intervention.

O4-73 [115] All equipment should be constructed to meet applicable functionality requirements continuously during waveform testing of [Section 5.4.1, “Earthquake Test Methods.”](#) These functionality criteria shall demonstrate that the equipment has sustained operation without loss of service during the testing.

The criteria for assessing functionality depend on the service provided by the equipment being tested. The criteria are determined by applying appropriate Telcordia generic requirements or, if none exists, by the supplier’s or purchaser’s own performance specifications.

4.4.2 Framework and Anchor Criteria

The following criteria apply to all framework and concrete expansion anchors used in network facilities. They are intended to ensure minimum limits for structural performance in earthquake environments are met.

O4-74 [116] Framework should be of welded construction.

R4-75 [117] Framework shall be constructed for base mounting to the floor without auxiliary support or bracing from the building walls or ceilings.

The static pull test methods of [Section 5.4.1.4, “Static Test Procedure,”](#) were developed as a developmental tool to evaluate framework strength prior to synthesized waveform testing. The test method is still useful to compare the strength of framework designs.

O4-76 [118] For framework used in earthquake risk zones, the static pull testing procedures of [Section 5.4.1.4, “Static Test Procedure,”](#) should be followed, meeting these objectives:

- The maximum single amplitude deflection at the top of the framework should not exceed 75 mm (*3 in*).
- The top of the framework should return to its original position, within 6 mm (*0.24 in*) when the load is removed.
- The framework should sustain no permanent structural damage during static framework testing.

The static pull objective does not need to be performed on:

- Equipment intended to be provided without framework,
- Equipment provided with framework that has previously been tested and found compliant with this objective, or
- Framework (loaded or unloaded) that has been synthesized waveform tested per [Section 5.4.1.5, “Waveform Test Procedure.”](#)

R4-77 [119] Concrete expansion anchors used to base mount framework to the floor shall meet the following requirements:

- Maximum embedment depth of 90 mm (*3.5 in*)
- Maximum bolt diameter of 13 mm (*0.5 in*).

O4-78 [120] Concrete expansion anchors used to base mount the framework to the floor should be suitable for earthquake (dynamic) applications, as specified by the manufacturer.

NOTE: Typical concrete anchors are not designed for dynamic loads, such as earthquakes. The above criterion specifies that the selected anchors should be designed to meet the dynamic loads specified in this document.

O4-79 [121] Concrete expansion anchors should use steel construction to minimize creep.

Concrete expansion anchors used for frame-level waveform testing must conform to the physical performance requirements of [Section 4.4.1, “Earthquake Environment and Criteria.”](#) If substitute fasteners are used in place of concrete expansion anchors

during frame-level testing, the peak fastener load calculated or measured during the tests must not exceed the preload specified for the concrete expansion anchors by the manufacturer.

4.4.3 Wall-Mounted Equipment Anchor Criterion

R4-80 [175] Fastening systems used for wall-mounted equipment shall withstand a force of 3 times the weight of the equipment applied to the equipment in any direction.

Wall-mounted equipment listed to the latest edition of **UL 60950**, *Safety of Information Technology Equipment*, conform to this requirement.

4.4.4 Office Vibration Environment and Criteria

4.4.4.1 Office Vibration Environment

Telecommunications equipment may be subjected to low-level vibration in service that is typically caused by nearby rotating equipment, outside rail or truck traffic, or construction work in adjacent buildings or spaces. This vibration can cause circuit board “walkout,” malfunctions, or other service interruptions or failures.

Network equipment shall be tested to determine its resistance to office vibrations. [Section 5.4.2, “Office Vibration Test Procedure,”](#) details vibration test methods.

4.4.4.2 Physical Performance Criteria

R4-81 [122] All equipment shall be constructed to sustain the office vibration testing of [Section 5.4.2, “Office Vibration Test Procedure,”](#) without permanent structural or mechanical damage.

4.4.4.3 Functional Performance Criteria

R4-82 [123] All equipment shall be constructed to meet applicable functionality requirements continuously during each axis of the office vibration testing of [Section 5.4.2, “Office Vibration Test Procedure.”](#) The equipment shall sustain operation without replacement of components, manual rebooting, or human intervention.

4.4.5 Transportation Vibration Criteria

4.4.5.1 Transportation Environment

Equipment will generally experience maximum vibration in the non-operating, packaged condition, during commercial transportation. The transit environment is complex. There are low-level vibrations of randomly distributed frequencies reaching 1 to 500 Hz with occasional transient peaks. The effects of this vibration can be determined by a random vibration test, as presented in [Section 5.4.3, “Transportation Vibration—Packaged Equipment,”](#) of this document.

[Figure 4-4](#) describes the vibration environment that occurs in commercial transportation. It covers transport by rail, truck, ship, and aircraft. This environment and the prescribed test condition are based on the European Telecommunications Standards Institute (ETSI), **EN 300 019-2-2 V2.1.2** (1999-09), *Equipment Engineering (EE); Environmental conditions and environmental tests for telecommunications equipment; Part 2-2: Specification of environmental tests; Transportation Specification T2.3: Public Transportation.*

R4-83 [124] Equipment shall not sustain any physical damage or deteriorate in functional performance when subjected to vibration levels expected during transportation.

Figure 4-4 Transportation Vibration Environment

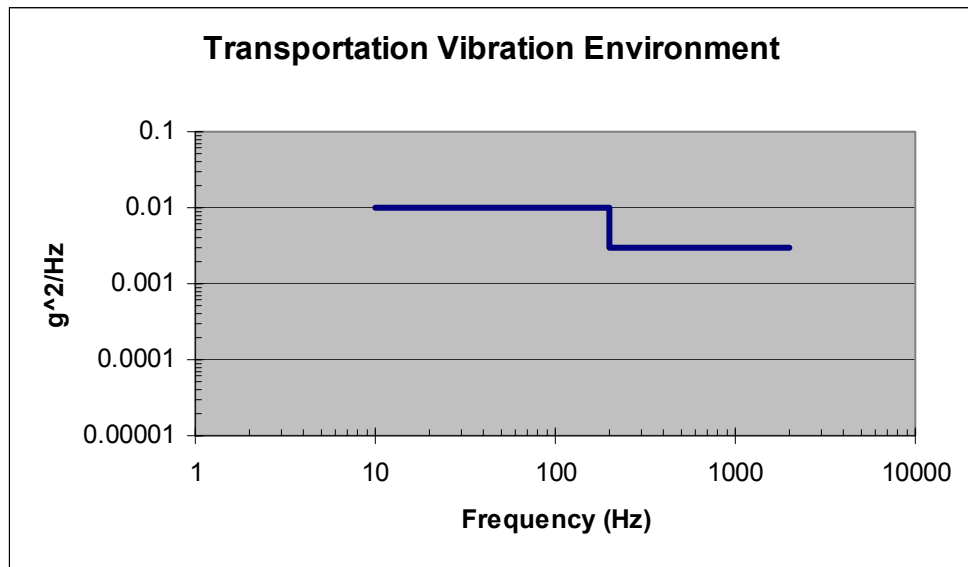

4.5 Airborne Contaminants

The concentration of indoor pollutants in a communications facility is a function of outdoor pollutant levels and indoor generation rates. [Table 4-11, “Outdoor Contaminant Levels,”](#) lists anticipated concentrations of selected contaminants

found in densely populated, urban, outdoor environments. [Table 4-12, “Indoor Contaminant Levels,”](#) lists anticipated concentrations of selected contaminants that can be found in environmentally controlled (air conditioned and filtered) network facilities.

Indoor particulate levels are a function of the degree of filtration of the outdoor air and the recirculated air. Indoor organic vapor and inorganic gas levels are more strongly influenced by the amount of outdoor air used for ventilation.

The values of [Table 4-11](#) represent the 95th percentile. This means that 95% of the time, the level of contaminant is lower than the listed value. Note that for NO and ozone, the values are the 95th percentile of the daily 1-hour maximum. The concentrations are based on Telcordia field measurements, Environmental Protection Agency (EPA) reports, and reviews of published air-quality studies. Contaminants have been measured independently, and the **tabulated concentrations do not necessarily occur at the same time or the same location.** In the past two decades, there have been significant reductions in outdoor concentrations of sulfur dioxide, oxides of nitrogen, and ozone.

The values of [Table 4-12](#) for fine particles, sulfur dioxide, hydrogen sulfide, oxides of nitrogen, and ozone indoor concentrations have been derived using predictive modeling and the 95th percentile values for these contaminants in the outdoor urban environment of [Table 4-11](#). The predictive modeling assumes a building with particulate filters rated 10% (ASHRAE Dust Spot Rating), continuous operation of the HVAC fans, and supply air consisting of 10% outdoor air and 90% recirculated air. The indoor levels of coarse particles, volatile organic compounds, ammonia, and gaseous chlorides are 95th percentile values based on field measurements.

Hygroscopic dust primarily consists of sulfate and nitrate salts. It is commonly found in air and can cause failures in printed wiring assemblies. Since the size of hygroscopic dust is quite small, it is difficult to filter out these particles.

4.5.1 Contamination Classes

Particulate Contamination — In general, dust is measured in two size ranges; particles with diameters less than or equal to 2.5 μm are called fine particles, and those with diameters greater than 2.5 μm are called coarse particles. The sum of the particulate concentrations ($\mu\text{g}/\text{m}^3$) in each of these two size ranges is referred to as Total Suspended Particulate (TSP).

In outdoor air, water soluble salts contribute as much as 50% of the mass of the fine-mode particles. Although the indoor levels of fine particles are lower than those found outdoors, the percentage of water-soluble salts is generally greater than 50%. In time, these salts will accumulate on equipment surfaces where they can lead to increased corrosion levels, surface leakage, and potential arcing problems, particularly when the relative humidity increases above 40%.

Coarse-mode particles have their greatest impact on the operation of connector and relay contacts. In most cases, coarse-mode particles do not cause surface leakage or corrosion unless the dust is metallic (and therefore conductive) or contains large amounts of chloride (e.g., road salt or sea salt).

Organic Vapors — Organic vapors in a network facility usually originate from indoor sources. Organic vapors can lead to contact activation and rapid erosion, frictional polymer on sliding contacts, and material deterioration. Organic vapors can also affect disk drive and magnetic tape reliability. This section only addresses organic contaminants whose boiling points are greater than 30°C.

Reactive Gases — The environment of a network facility can contain reactive gases such as sulfur dioxide, oxides of nitrogen, ozone, hydrogen sulfide, and gaseous chlorine at levels that can reach outdoor pollution levels. Most of these gases corrode metal surfaces. Ozone can lead to degradation of polymeric materials and is a factor to be considered in materials selection. Recent studies show ammonia can potentially have an impact on optical fiber strength.

4.5.2 Contamination Levels

4.5.2.1 Environmentally Controlled Space

R4-84 [125] It is a requirement that equipment intended for installation in controlled environmental space operate for its intended service life within the average yearly levels of contamination listed in [Table 4-12, “Indoor Contaminant Levels.”](#) Conformance to this requirement for reactive gases and hygroscopic fine particulate can be demonstrated through the test methods given in [Section 5.5, “Airborne Contaminants Test Methods.”](#)

NOTE: The recommended test duration for the reactive gaseous contaminants exposure is 10 days per [Section 5.5](#). This corresponds to roughly 15 years of equipment service life. If testing to a service life of 20 years is desirable, an exposure duration of 14 days is required.

No measures are employed to remove gaseous contaminants (listed in [Table 4-11](#) and [Table 4-12](#)) in building filtration techniques. Consequently, indoor concentrations of these gases/vapors can approach outdoor levels. Furthermore, due to the indoor sources of volatile organic compounds and ammonia, these contaminant levels can be considerably higher than outdoor levels (see [Table 4-11](#)).

O4-85 [126] This objective has been deleted per Issue 2.

Table 4-11 Outdoor Contaminant Levels

Contaminant	Concentration **
Airborne Particles (TSP - Dichot 15)*	90 µg/m ³
Coarse Particles	50 µg/m ³
Fine Particles	50 µg/m ³
Water Soluble Salts	30 µg/m ³
Sulfate	30 µg/m ³
Nitrites	12 µg/m ³
Volatile Organic Compounds (boiling point > 30°C)	400 ppb 1600 µg/m ³
Sulfur Dioxide	150 ppb
Hydrogen Sulfide	40 ppb
Ammonia	50 ppb
Oxides of Nitrogen	
NO	500 ppb
NO ₂	250 ppb
HNO ₃	50 ppb
Ozone	250 ppb
Gaseous Chlorine (HCl + Cl ₂)	6 ppb

* TSP - Dichot 15 = total suspended particulates determined using a dichotomous sampler with a 15-µm inlet.

** µg/m³ = micrograms per cubic meter.

ppb = parts per billion.

Table 4-12 Indoor Contaminant Levels

Contaminants	Concentration **
Airborne Particles (TSP - Dichot 15)*	20 µg/m ³
Coarse Particles	< 10 µg/m ³
Fine Particles	15 µg/m ³
Water Soluble Salts	10 µg/m ³
Sulfate	10 µg/m ³
Nitrites	5 µg/m ³
Volatile Organic Compounds (boiling point > 30°C)	1200 ppb 5000 µg/m ³
Sulfur Dioxide	50 ppb
Hydrogen Sulfide	40 ppb
Ammonia	500 ppb
Oxides of Nitrogen	
NO	500 ppb
NO ₂	200 ppb
HNO ₃	15 ppb
Ozone	125 ppb
Gaseous Chlorine (HCl +Cl ₂)	5 ppb

* TSP - Dichot 15 = total suspended particulates determined using a dichotomous sampler with a 15-µm inlet.

** µg/m³ = micrograms per cubic meter.

ppb = parts per billion.

4.5.2.2 Outside Plant (OSP) Equipment

R4-86 [127] It is a requirement that equipment intended to function in outdoor air, such as cabinets installed on pads or poles, with little or no filtration should operate reliably for the intended service life at the contaminant levels listed in [Table 4-11, “Outdoor Contaminant Levels.”](#) Conformance to this requirement for reactive gases and hygroscopic fine particulates can be demonstrated through the test methods given in [Section 5.5, “Airborne Contaminants Test Methods.”](#)

The values listed in these tables are based on Telcordia field measurements, EPA reports, and reviews of published air-quality studies.

4.5.3 Measurement of Contaminant Levels

The **TSP - Dichot 15** levels are based on measurements with a dichotomous sampler that size-fractionates the collected particles into two modes: fine particles (less than or equal to 2.5 μm) and coarse particles (from 2.5 to 15.0 μm). Particles are collected on Teflon membrane filters and weighed to determine TSP. Collection times range from 1 to 7 days. The relative composition of the indoor dust should be approximately the same as the outdoor dust. The percentage of fine particles, including water-soluble salts, may be higher indoors due to filtration efficiency characteristics.

Water-soluble salts can be directly determined by water extraction of the collected particles, followed by ion-chromatographic analysis. Organic vapors can be determined by passive or active sampling followed by Gas Chromatographic/Mass Spectroscopic (GC/MS) analysis of the collected compounds. The various gases are determined by standard spectroscopic techniques.

4.5.4 Equipment - Fan Filters

Accumulation of dust on telecommunications products can provide the potential for electrical breakdown. As a result, equipment design rules need to include adequate spacings or shielding to avoid surface bridging due to settling, electrostatic or thermophoretic deposition of dust. For example, electrostatic deposition increases with increasing electrical fields.

These criteria are based on those in **GR-78-CORE**.

Forced air-cooled equipment shall be fitted with suitable filters to remove particulate matter that has not yet been filtered out by the return air systems of the building. These particles are usually greater than 2 microns in size and are generated by people and mechanical processes within the switch room. They usually include human debris, paper and textile fibers, and coarse dust carried in from outside by the building occupants.

R4-87 [138] All fan-cooled equipment shall be equipped with filters. Fan filters shall be replaceable with equipment operating. Fans used to cool the outside of sealed equipment cabinets need not be fitted with particulate filters.

R4-88 [139] All equipment fan filters used in equipment occupying over 2U of vertical rack space (90 mm or 3.5 in) shall have either a:

- Minimum dust arrestance of 80%, per **ASHRAE Standard 52.1**, *Gravimetric and Dust-Spot Procedures for Testing Air Cleaning Devices Used in General Ventilation for Removing Particulate Matter*, 1992, or
- Minimum Efficiency Rating Value (MERV) of 4, per **ASHRAE Standard 52.2**, *Method of Testing General Ventilation Air Cleaning Devices for Removal Efficiency by Particle Size*, 1999.

- R4-89 [176]** All equipment fan filters used in equipment occupying 2U of vertical rack space (90 mm or 3.5 in) or less shall have either a:
- Minimum dust arrestance of 65%, per **ASHRAE Standard 52.1**, *Gravimetric and Dust-Spot Procedures for Testing Air Cleaning Devices Used in General Ventilation for Removing Particulate Matter*, 1992, or
 - Minimum Efficiency Rating Value (MERV) of 2, per **ASHRAE Standard 52.2**, *Method of Testing General Ventilation Air Cleaning Devices for Removal Efficiency by Particle Size*, 1999.
- R4-90 [140]** Fan filters shall have a minimum fire rating of Class 2 per **UL 900**, *Standard Air Filter Units*, 1994.
- NOTE:** Polymer filter media must also meet the fire-resistance requirements per [Section 4.2.3.1, “Material/Components Fire-Resistance Criteria.”](#)
- R4-91 [141]** Construction and system fit of equipment fan filters shall prevent any air bypass. Inadvertent leakage that may result from mechanical fits or tolerances, (examples may include spaces between circuit pack face plates, connector or cable matrices, chassis screw or mounting holes, etc.), is not considered bypass.
- R4-92 [142]** Equipment shall have provision for fan-filter replacement with the fans shut down or blocked to prevent handling contamination. Some designs where the filters are withdrawn from the air flow for removal (e.g., door mounted filters) satisfy the intent of this requirement.
- R4-93 [143]** The equipment manufacturer shall provide a method for determining equipment fan filter replacement schedules.
- O4-94 [144]** If possible, active alarming should be provided to indicate the need for fan filter replacement.
- O4-95 [145]** It is an objective that equipment fan filters are disposable and not the types that require removal and cleaning.

4.6 Acoustic Noise

Sound power is the preferred quantity to use for characterizing and rating acoustical noise emissions from telecommunications equipment. Sound power measurements provide measurement uniformity, and accuracy over previous sound pressure level methods. The criteria and methodology of this document are based on the draft of the Alliance for Telecommunications Industry Solutions (ATIS) Standard, *Acoustic Measurement*, **ATIS-0600005**.

The limits apply only to the airborne acoustic noise generated by equipment during operation under the conditions described. The noise limit for equipment under maintenance conditions (i.e., with door opened) is not defined and this condition need not be measured. The noise limit while operating at maximum fan speed is

likewise not defined, but this condition must be measured. The limits also do not apply to equipment features that produce sound as an intentional aspect of their operation, such as alarm signals, attention signals or speech signals.

The criteria apply to equipment intended to be installed in a line-up or as stand-alone pieces of equipment.

The sound power-level limits apply to the normal operating conditions where equipment is configured and equipped in its deployed state with the approved configurations, that produce the loudest noise. This includes all components, applicable accessories, and any acoustic shields or other apparatus that will be part of the equipment.

The acoustical noise emission limits for telecommunications equipment to be installed in temperature-controlled environments are stated in [Table 4-13, “Acoustical Noise Emission Limits.”](#) These limits are in terms of the declared A-weighted sound power level, L_{WAAd} . This quantity has been standardized worldwide for the declaration of acoustical noise emission values and represents a statistical upper limit value. Although the actual L_{WAAd} will depend on the particular product and test case variability, it will generally be about 3 dB above the mean, or measured, value of the A-weighted sound power level, L_{WA} . The limits of [Table 4-13](#) apply to equipment in a representative (typical or principal) configuration (which must be identified or described in the test report). If this configuration consists of multiple frames, racks, or cabinets connected together, the limits apply to each frame rack, or cabinet, individually.

R4-96 [128] Under normal operation, equipment shall not produce declared A-weighted sound power level (L_{WAAd}) above the limits shown in [Table 4-13](#).

Table 4-13 Acoustical Noise Emission Limits

Environmental Description	Declared Sound Power Level L_{WAAd} (dB)	Temperature* (°C)
Equipment to be Located in Telecommunications Room (attended)	78	27
Equipment to be Located in Telecommunications Room (unattended)	83	27
Equipment to be Located in Power Room	83	27

* Maximum acoustic level that occurs between 23°C and 27°C should be measured (see [Section 5.6, “Acoustical Measurement Methodology,”](#) for clarification.)

The intent of requirement **R4-96 [128]** is to characterize the noise level of the equipment in a CO that may typically operate at a temperature of 27°C (81°F). For this reason, laboratory measurements to determine sound power are made in an environment simulating operation at this temperature.

Maximum noise produced by high-speed fan operation, which may occur in some products at higher temperatures, is also determined.

R4-97 [177] The sound power level produced by equipment while operating at maximum fan speed shall be measured and provided.

4.7 Illumination

In the planning of network equipment spaces, it is important to provide adequate lighting at all work locations. The lighting system and equipment designs must both be optimized to provide for efficient use of the provided light while reducing the chance for human error.

Section 5.7, “Lighting Test Methods,” presents the lighting test methods. Illumination measurements can be affected by light-meter characteristics and accuracy, the way the meter is used, and the arrangement of lighting equipment. Field measurements should be made with a light meter that gives the correct relative responses to light arriving from all directions within the hemisphere.

4.7.1 Illumination Criteria for Central Office (CO) Lighting Systems

4.7.1.1 Quantity of Light

R4-98 [129] CO lighting systems shall maintain the minimum levels of illumination in CO equipment areas according to Table 4-14, “Minimum Maintained Illumination Level.”

O4-99 [130] New lighting systems should provide initial illumination levels at least 25% higher (to account for losses due to lamp lumen depreciation and dirt accumulation in the luminaires), but no more than 50% higher (to account for modularity of the lighting equipment) than the levels listed in Table 4-14, “Minimum Maintained Illumination Level.”

Table 4-14 Minimum Maintained Illumination Level

Equipment	Level Lux (Footcandles)
Equipment Frame Area <ul style="list-style-type: none"> • Maintenance aisle • Wiring aisle 	160* (15) No design level (use portable lighting during maintenance)
Distributing Frame Area <ul style="list-style-type: none"> • Maintenance aisle • Wiring aisle 	215* (20) 110* (10)
Power and Battery Areas <ul style="list-style-type: none"> • Aisles and open spaces • ac switchboards and dc battery distribution boards (measure at center of board) 	320** (30) 220 (20)
Cable Entrance Area <ul style="list-style-type: none"> • Aisles and open spaces 	55 (5)
Control, Test, and Maint. Areas <ul style="list-style-type: none"> • Control center of test frame (measure on shelf) • Print display board (measure at center of board) • Desktop (measure on writing surface) 	540 (50) 540 (50) 540 - 750 (50 - 70)

* Illumination should be measured on the vertical equipment surface 762 mm (30 in) above the floor with the meter aimed across the aisle. Do not allow shadows to fall on the light-sensitive cell.

** Illumination should be measured in the aisle's center, 1524 mm (60 in) above the floor, with the meter aimed upward.

R4-100 [131] The lighting system shall use energy efficient components (lamps, ballasts, etc.).

4.7.1.2 Luminance Ratios

Excessive luminance (photometric brightness) differences within the field of view cause discomfort, fatigue, and reduced efficiency.

04-101 [134] The luminances of surfaces immediately adjacent to the visual task should be at least one-third that of the task, and should not exceed the luminance of the task. For more remote surfaces, the luminance of any significant surface normally viewed directly should be between one-third and five times the luminance of the task.

4.7.1.3 Color of Light

04-102 [135] In all new installations, fluorescent lamps should be used in equipment and operating areas because of their relatively high light output per watt. As a standard practice, it is recommended that fluorescent lamps with good color rendition be used.

4.7.2 Illumination Criteria for Network Equipment

4.7.2.1 Surface Reflectance and Color

04-103 [132] The surface reflectance of equipment should be treated as elements of the lighting system. Light (high reflectance) surfaces should be used as they are much more efficient than dark surfaces in conserving light and distributing it uniformly. Finish textures should be matte or flat rather than glossy; this aids in distributing light evenly and minimizing reflected glare.

White surfaces give the highest reflectance-about 80%. Conversely, black is the poorest reflector, with reflectance close to 0. Medium groups have a reflectance of about 30%. [Section 5.7, "Lighting Test Methods,"](#) presents a method to measure reflectance.

4.7.2.2 Glare

Glare is the sensation produced by luminances in the visual field that are greater than that to which the eyes are adapted, causing annoyance, discomfort, or loss in visual performance and visibility. It is produced by either direct light from windows or luminaires, or by light reflected from polished or glossy surfaces.

04-104 [133] Equipment designers and lighting designers should take steps to control glare.

Direct glare can be minimized or eliminated by one or more of the following:

- The light source can be removed from the field of view.
- The light source can be modified to reduce or eliminate the direct light seen by the observer.
- The brightness of the source can be reduced.

Reflected glare can be minimized or eliminated by one or more of the following:

- Surface reflectance can be reduced.
- Reflecting surfaces, such as transparent covers, can be mounted over printed information (e.g., flat key caps) at angles that do not reflect light into the eye.
- Relative locations of luminaires and work surfaces can be controlled.
- The directions in which light is radiated by luminaires can be controlled.

Section 5.7, “Lighting Test Methods,” presents a test method for equipment glare.

5 Environmental Test Methods

Section 4, “Environmental Criteria,” specifies the environmental requirements for network equipment. This section provides test methods for determining whether equipment meets those environmental criteria. Although criteria may specify operation at certain conditions (e.g., 96 hours), test methods will often utilize differing conditions for testing purposes. A test report verifying that these requirements have been met should be prepared and should include the following:

- Sketches or photographs of the test setup
- All recorded data
- Any deviations from the NEBS requirements and test procedures
- A description of the equipment’s functionality test used (to establish equipment operability)
- Observer comments.

Each subsection may have additional requirements.

In order to ensure consistency and repeatability of test results, it is expected that all test facilities shall be available for review and provide access for witnessing during all aspects of the testing by the participating clients.

5.1 Temperature, Humidity, and Altitude Test Methods

This section provides test methods for the temperature, humidity, and altitude environments specified in Section 4.1.

Equipment may be tested in the following configurations:

- **Frame-level** — A fully-loaded equipment frame or frames, or a single equipment shelf more than 36 inches in height.
- **Shelf-level** — A single equipment shelf less than or equal to 36 inches in height.

A. General Testing Requirements

During the operational tests the equipment shall operate, using as many functions as deemed practical. For the non-operating tests, the equipment shall be tested for operability before and after each test.

The operational state of the equipment shall simulate the configuration for actual service conditions.

The criteria for assessing functionality shall be included in a written test plan. The criteria depend on the service provided by the equipment being tested, and are determined by applying appropriate Telcordia generic criteria, or, if none exists, by the supplier's or purchaser's performance specifications.

All tests shall be conducted in a thermal chamber capable of producing the temperature and humidity conditions given in the test procedure. For operational tests on products cooled by forced air, the thermal chamber volume should be at least 5 times the volume of the equipment under test. For operational tests on products cooled by natural convection, the thermal

chamber volume shall be at least 5 times the volume of the equipment under test, and the airflow near the equipment space shall not exceed 1m/second. Chamber airflow velocity can be assessed prior to insertion of equipment under test.

Temperature and humidity sensors shall be calibrated for the ranges of temperature and humidity expected during the test, and shall be capable of measuring with sufficient accuracy to ensure the tolerances in the procedure are satisfied.

All powering, interfacing, and monitoring equipment that is not part of the equipment being tested should be located outside the chamber.

B. Tolerances

Unless otherwise specified, the temperature shall be maintained within $\pm 3^{\circ}\text{C}$, and the relative humidity within $\pm 3\%$. Dwell time durations specified in test methods are minimums and may be extended.

C. Ambient Temperature/Relative Humidity

Unless otherwise specified, ambient temperature is defined as a temperature between 20°C (68°F) and 30°C (86°F) and ambient relative humidity is defined to be a relative humidity between 5% - 85%.

D. Temperature Gradient

In the thermal tests below, the maximum cooling gradient is specified at 30°C/hr (54°F/hr). The maximum heating gradient is specified at 96°C/hr (173°F/hr). Thermal chambers shall be capable of achieving this gradient over the specified temperature range.

E. Test Report

A written test report shall verify that the test was conducted properly and that the equipment functionality was maintained. The test report shall include a description of the test chamber in terms of the appropriate requirements and objectives, and shall incorporate the following information:

- Sketches or photos of the test configuration
- A description of the equipment under test and the service it provides
- The criteria for assessing functionality, including the required functionality at both the normal and short-term operating conditions for operating temperature and humidity tests.

NOTE: For operating temperature and relative humidity testing, core or critical functions must be maintained at the short-term operating conditions. Any designed reduction in equipment functionality at the short-term operating conditions must be justified in the test report. Full equipment functionality must self-restore when the temperature or humidity return to the normal range.

- All temperatures (including internal equipment temperatures), humidity conditions, and functionality data (including any calculations)
- A description of any hardware or software failures, plus a list of all replacements that were made, if any.

5.1.1 Transportation and Storage Test Methods

This section presents test methods for determining whether equipment can withstand the temperature and humidity environments encountered during transportation and storage as specified in [Section 4.1, “Temperature, Humidity, and Altitude Criteria.”](#) The equipment does not operate during these tests, but appropriate functionality measurements should be made on equipment before and after each test or sequence of tests. Packaged equipment should be used in these tests. If, for some reason, this is not possible (e.g., the packaging is not available), these tests may be conducted on unpackaged equipment, provided that the

- Packaging can be reasonably assumed not to influence the testing results, and
- Packaging will itself resist the temperature and humidity package stresses.

Packaging that includes a moisture barrier should always be included in the high humidity and low temperature exposure and shock tests because such barriers affect product conformance for these tests.

Note 1— Tests may be performed sequentially on a single sample or parallel.

Note 2— If the likelihood of nonconformance from a given test is small, a sequence of several tests may be performed before the equipment operational test is performed. However, if a nonconformance occurs, the tests will have to be repeated to determine which environment caused the nonconformance.

Note 3— If testing sequentially on a single sample, the suggested test sequence is low temperature exposure and thermal shock, followed by high humidity exposure, and finally high-temperature exposure and thermal shock. Adequate time for product recovery after the shocks should be allowed. This will permit the equipment’s temperature to moderate, and any resulting condensation to evaporate, before performing the equipment’s functionality test or continuing the package test sequence.

Note 4— For transportation and storage methods, test sample insertion into a chamber kept at the specified extreme environments is permitted if a manufacturer agrees to this method. The exposure duration shall be extended to include the omitted ramping time provided in this document.

5.1.1.1 Low-Temperature Exposure and Thermal Shock

1. Make initial equipment functionality test at ambient temperature and humidity level.
2. Package the equipment and place it into the test chamber.
(Do not operate the equipment during the test.)
3. Monitor the chamber temperature continuously during the test.
4. Decrease the chamber temperature, at a rate of about 30°C/hr (54°F/hr) to -40°C (-40°F).
5. Maintain a temperature -40°C (-40°F) for a minimum of 72 hours.
6. Administer the thermal shock by increasing the chamber temperature (or removing the equipment from the chamber) from -40°C (-40°F) to ambient in less than 5 minutes. (Use appropriate personal protective equipment when handling the package.)
7. Perform a post-test equipment functionality check after the equipment has recovered at ambient temperature and humidity.

Figure 5-1 shows low-temperature exposure and thermal shock.

Figure 5-1 Low-Temperature Exposure and Thermal Shock

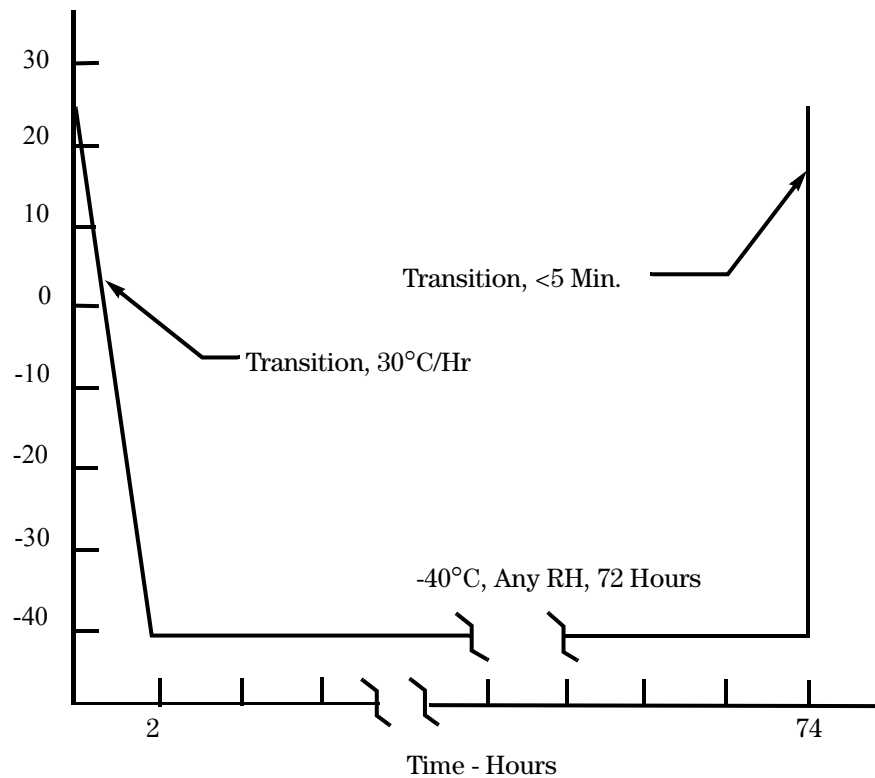

5.1.1.2 High Relative Humidity Exposure

1. Make initial equipment functionality test at ambient temperature and humidity level.
2. Package the equipment and place it into the test chamber at 23°C (73°F) and 50% RH. (Do not operate the equipment during the test.)
3. Monitor the chamber temperature and RH continuously during the test.
4. Increase the chamber temperature, at a rate of 30°C/hr (54°F/hr) to 40°C (104°F).
5. While holding the chamber at 40°C (104°F), transition the chamber's RH to 93%. This RH shall be achieved in < 2 hours.
6. Maintain a temperature 40°C (104°F) and a RH of 93% for at least 96 hours.
7. While holding the chamber at 40°C (104°F), transition the chamber's RH to 50%. This RH shall be achieved in < 2 hours.
8. Transition the chamber to 23°C (73°F) at a rate of 30°C/hr (54°F/hr) while maintaining 50% RH.
9. Perform a post-test equipment functionality check after the equipment has recovered at ambient temperature and humidity.

Figure 5-2 shows high relative humidity exposure.

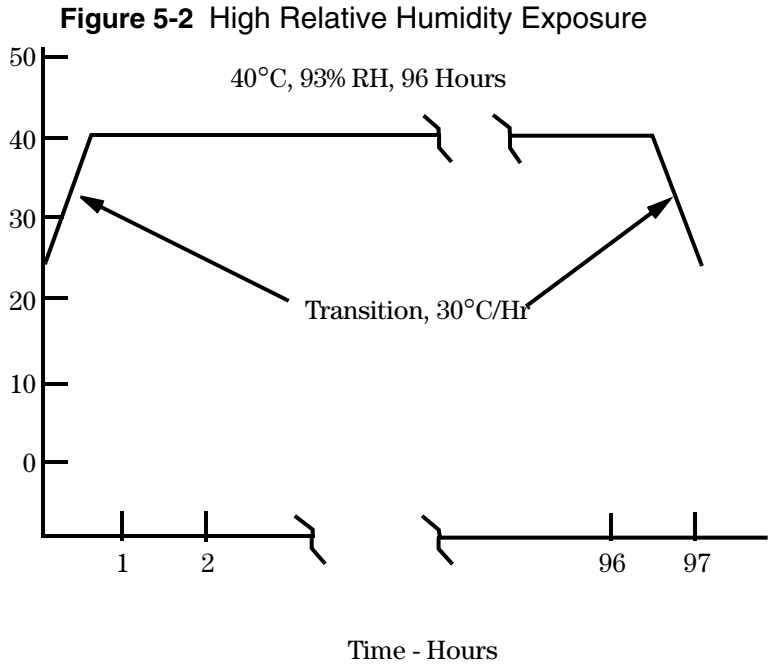

5.1.1.3 High-Temperature Exposure and Thermal Shock

1. Make initial equipment functionality test at ambient temperature and humidity level.
2. Package the equipment and place it into the test chamber.
(Do not operate the equipment during the test.)
3. Monitor the chamber temperature continuously during the test.
4. Increase the chamber temperature, at a rate of 30°C/hr (54°F/hr) to 70°C (158°F).
5. Maintain a temperature 70°C (158°F) for a minimum of 72 hours.
6. Administer the thermal shock by decreasing the chamber temperature (or removing the equipment from the chamber) from 70°C (158°F) to ambient in less than 5 minutes. (Use appropriate personal protective equipment when handling the package.)
7. Perform a post-test equipment functionality check after the equipment has recovered at ambient temperature and humidity.

Figure 5-3 shows high-temperature exposure and thermal shock.

Figure 5-3 High-Temperature Exposure and Thermal Shock

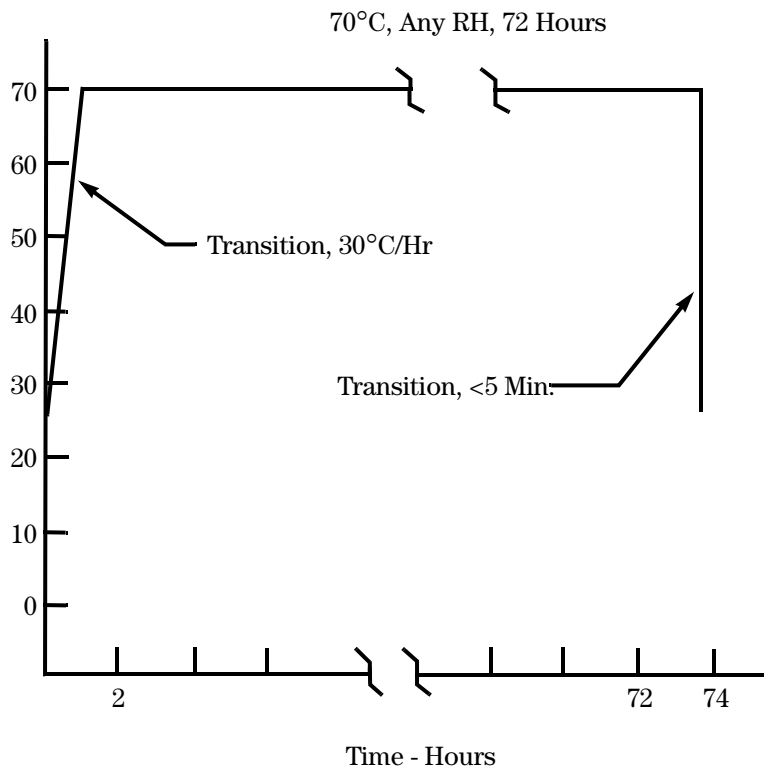

5.1.2 Operating Temperature and Relative Humidity

This section presents a test method to determine whether the equipment can operate in the environment of [Table 4-4, “Ambient¹ Temperature and Humidity Limits.”](#) During the test, the equipment is operating. Conformance is based on the ability of the equipment to operate at each test condition.

Ideally, the equipment and test chamber will operate without interruption for the duration of the test. If testing is interrupted due to chamber failure, power failure, etc., the testing shall be adjusted or repeated such that continuous operation during the high temperature dwell, low temperature dwell, high humidity dwell, and specified rates of change have each been demonstrated. No inference of cumulative stress upon the test equipment is presumed from the test sequence.

If the product encounters a functional anomaly that is known to occur at ambient conditions, affected test steps may be repeated to demonstrate the functional anomaly is not a result of the test environment. If the product encounters a functional anomaly which requires a replacement of hardware to correct, a Root Cause Analysis (RCA) shall be performed and the test cycle repeated in full.

The step numbers below are graphically represented in [Figure 5-4, “Operating Temperature and Humidity - Temperature vs. Time for Frame-Level Test.”](#) [Figure 5-5, “Temperature and Humidity Sensor Locations for Frame-Level Test,”](#) provides the placement for temperature and humidity sensors for a frame-level test. The chamber control set-points shall be adjusted as to maintain the temperature and humidity at this location as defined in the test parameters. For shelf-level tests, monitor the air inlet conditions.

Test Sequence - Monitor the chamber’s ambient temperature continuously during the test. Please note the 50°C high temperature condition is applied to frame-level equipment. For shelf-level equipment, a high temperature of 55°C (131°F) shall be used. For other equipment types, such as Digital Loop Carrier Remote terminals, other high and low temperatures can be substituted. Thermal stability is assumed to be achieved after 4 hours.

1. Operate the equipment at an ambient temperature of 23°C (73°F) and RH level 50% for a minimum period of 4 hours to verify that equipment has achieved operational stability.
2. (a) For frame-level equipment, increase the chamber’s temperature at a rate of 30°C/hr (54°F/hr) to 50°C (122°F). Attain less than a 32% RH level by the time the target temperature is attained.
(b) For shelf-level equipment, increase the chamber’s temperature at a rate of 30°C/hr (54°F/hr) to 55°C (132°F). Attain less than a 25% RH level by the time the target temperature is attained.
3. Maintain this temperature for 16 hours.
4. During these 16 hours, further reduce the RH to less than 15%.
5. Decrease the chamber’s temperature at a rate of 30°C/hr (54°F/hr) to -5°C (23°F). RH is not controlled.
6. Maintain a temperature -5°C (23°F), any RH for 16 hours.

7. Increase the chamber's temperature at a rate of 30°C/hr (54°F/hr) to 5°C (41°F). RH is not controlled.
8. Increase the chamber's temperature at a rate of 30°C/hr (54°F/hr) to 28°C (82°F). Increase the RH to attain a 90% level by the time the target temperature is attained.
9. Maintain a temperature 28°C (82°F) and the RH of 90% for 96 hours.
10. Increase the chamber's temperature at a rate of about 30°C/hr (54°F/hr) to 40°C (104°F). Decrease the RH to attain a 47% level by the time the target temperature is attained.
11. Decrease the chamber's temperature at a rate of 30°C/hr (54°F/hr) to 23°C (73°F).
12. Maintain a temperature 23°C (73°F) for 4 hours. RH may be uncontrolled.
13. Increase the chamber's temperature at a rate of about 96°C/hr (173°F/hr) to 50°C (122°F). RH may be uncontrolled.
14. Maintain a temperature 50°C (122°F) for 4 hours. RH may be uncontrolled.
15. Decrease the chamber's temperature at a rate of about 30°C/hr (54°F/hr) to 23°C (73°F). RH may be uncontrolled.

Figure 5-4 shows operating temperature and humidity - temperature vs. time for the frame-level test. Figure 5-5 shows temperature and humidity sensor locations for the frame-level test.

Figure 5-4 Operating Temperature and Humidity - Temperature vs. Time for Frame-Level Test

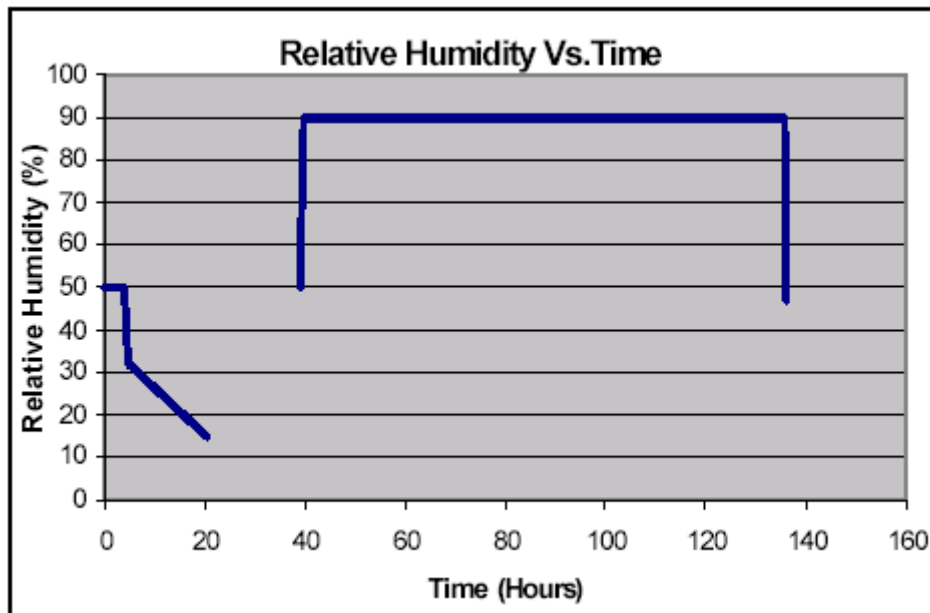
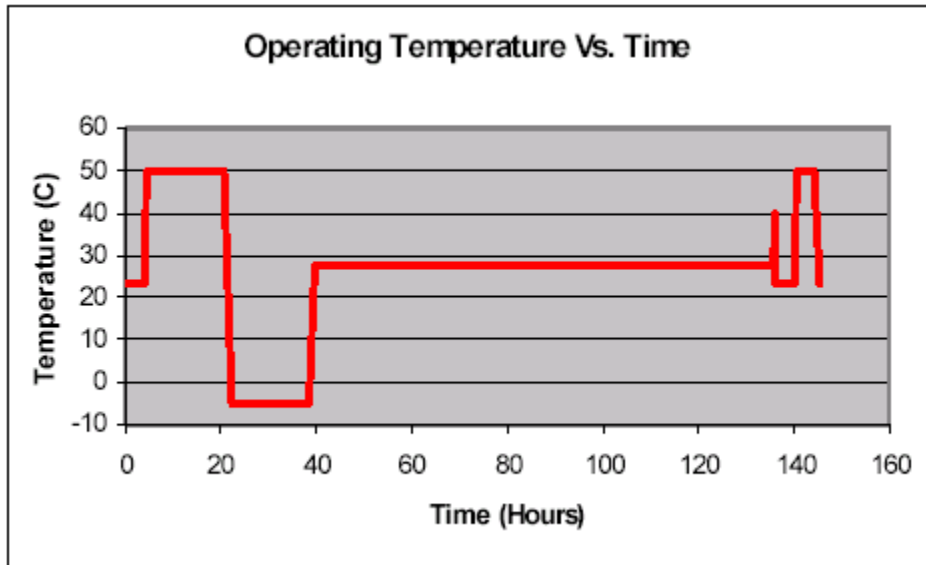
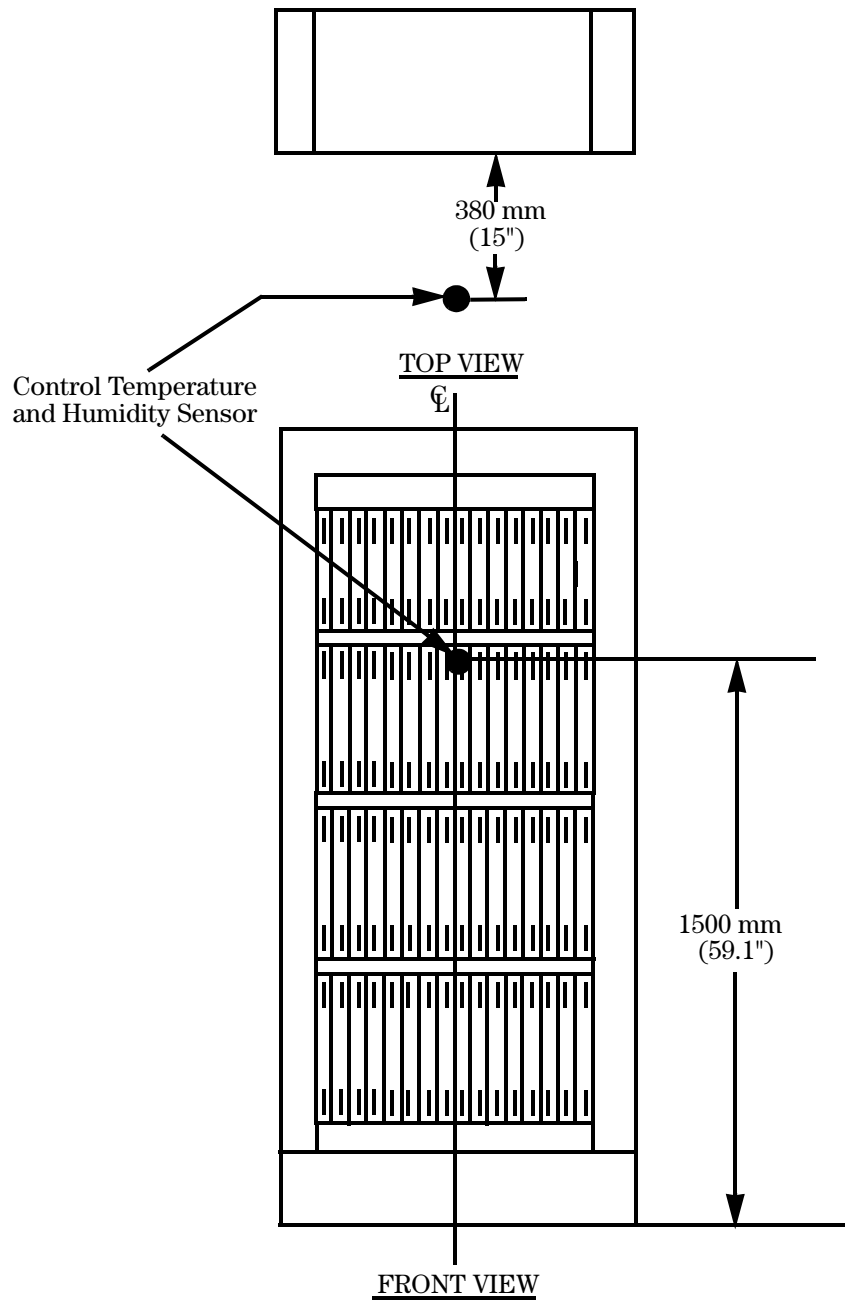

Figure 5-5 Temperature and Humidity Sensor Locations for Frame-Level Test



5.1.3 Operating Altitude

This section presents a test method to determine whether the equipment can operate in the altitude and temperature environments described in [Section 4.1.3, “Altitude.”](#) During the test, the equipment is operating. The thermal and mechanical effects of altitudes above sea-level are simulated through the use of reduced air pressures. Conformance is based on the ability of the equipment to operate throughout the test period. RH need not be controlled.

An alternative method of temperature compensation to simulate *thermal* altitude effects may be used. Simulation using a linear compensation of 1°C/1000 ft has been shown to be conservative for most products, and is suggested.

This method is only suitable for systems with no mechanical sensitivities. Mechanical sensitivities include items such as hard disk drives, sealed relays, fuel cells, or other items that may be mechanically affected by a change in differential pressure.

If using such an approach, increasing the high temperature condition in Steps 2 through 4 of the Operating Temperature and Relative Humidity Test is acceptable. This would result in a 6°C increase beyond the 50°C frame-level or 55°C shelf-level test conditions to account for thermal altitude effects. Such a method would be sufficient to demonstrate conformance to [O4-11 \[137\]](#), and simultaneously envelope [O4-12 \[76\]](#), [R4-9 \[136\]](#), and [R4-8 \[74\]](#).

NOTE 1: Tolerance on dwells is $\pm 2^{\circ}\text{C}$ for temperature and ± 3 kPa for pressure. A pressure of 80 kPa is analogous to 1800 meters above sea-level. A pressure of 60 kPa is analogous to 4000 meters above sea-level.

NOTE 2: The prescribed ramp rates for temperature and pressure are guidelines suitable for most products. Other ramp rates may be used.

Option 1: Combined Altitude Test Sequence - This test sequence may be used to demonstrate conformance to both the requirement and objective criteria. The high altitude and high temperature test conditions relevant to [R4-9 \[136\]](#), [O4-11 \[137\]](#), and [O4-12 \[76\]](#) are explicitly tested. Conformance to [O4-11 \[137\]](#) is used to demonstrate conformance to [R4-8 \[74\]](#). The dwell at the [R4-9 \[136\]](#) condition may be eliminated to reduce test duration if testing only to worst case conditions is desired.

Test Sequence 1 - Frame-Level

Monitor the chamber’s ambient temperature and absolute pressure continuously during the test.

1. Operate the equipment at an ambient temperature of 25°C and ambient pressure.
2. Increase the chamber’s temperature at a rate of 30°C/hr to 40°C.
3. Increase the chamber’s temperature at a rate of 5°C/hr to 50°C.
4. Decrease the chamber’s pressure at a rate of 15 kPa/hr to 80 kPa.
5. Maintain a condition of 50°C and 80 kPa for 8 hours. ([O4-11 \[137\]](#))
6. Decrease the chamber’s temperature at a rate of 5°C/hr to 30°C.
7. Decrease the chamber’s pressure at a rate of 15 kPa/hr to 60 kPa.

8. Maintain a condition of 30°C and 60 kPa for 8 hours. (R4-9 [136])
9. Increase the chamber's temperature at a rate of 30°C/hr to 40°C.
10. Maintain a condition of 40°C and 60 kPa for 8 hours. (O4-12 [76])
11. Increase the chamber's pressure at a rate of 15 kPa/hr to ambient.
12. Decrease the chamber's temperature at a rate of 5°C/hr to 25°C.
13. Test is complete.

Test Sequence 2 - Shelf-Level

Monitor the chamber's ambient temperature and absolute pressure continuously during the test.

1. Operate the equipment at an ambient temperature of 25°C and ambient pressure.
2. Increase the chamber's temperature at a rate of 30°C/hr to 45°C.
3. Increase the chamber's temperature at a rate of 5°C/hr to 55°C.
4. Decrease the chamber's pressure at a rate of 15 kPa/hr to 80 kPa.
5. Maintain a condition of 55°C and 80 kPa for 8 hours. (O4-11 [137])
6. Decrease the chamber's temperature at a rate of 5°C/hr to 35°C.
7. Decrease the chamber's pressure at a rate of 15 kPa/hr to 60 kPa.
8. Maintain a condition of 35°C and 60 kPa for 8 hours. (R4-9 [136])
9. Increase the chamber's temperature at a rate of 30°C/hr to 45°C.
10. Maintain a condition of 45°C and 60 kPa for 8 hours. (O4-12 [76])
11. Increase the chamber's pressure at a rate of 15 kPa/hr to ambient.
12. Decrease the chamber's temperature at a rate of 5°C/hr to 25°C.
13. Test is complete.

Option 2: Altitude Requirements Test Sequence - This test option may be used when it is desired to demonstrate conformance to the required criteria only. The high altitude and high temperature test conditions relevant to R4-8 [74] and R4-9 [136] are explicitly tested.

Test Sequence 1- Frame-Level

Monitor the chamber's ambient temperature and absolute pressure continuously during the test.

1. Operate the equipment at an ambient temperature of 25°C and ambient pressure.
2. Increase the chamber's temperature at a rate of 30°C/hr to 40°C.
3. Decrease the chamber's pressure at a rate of 15 kPa/hr to 80 kPa.
4. Maintain a condition of 40°C and 80 kPa for 8 hours. (R4-8 [74])
5. Decrease the chamber's temperature at a rate of 5°C/hr to 30°C.
6. Decrease the chamber's pressure at a rate of 15 kPa/hr to 60 kPa.
7. Maintain a condition of 30°C and 60 kPa for 8 hours. (R4-9 [136])

8. Increase the chamber's pressure at a rate of 15 kPa/hr to ambient.
9. Decrease the chamber's temperature at a rate of 5°C/hr to 25°C.
10. Test is complete.

Test Sequence 2 - Shelf-Level

Monitor the chamber's ambient temperature and absolute pressure continuously during the test.

1. Operate the equipment at an ambient temperature of 25°C and ambient pressure.
2. Increase the chamber's temperature at a rate of 30°C/hr to 45°C.
3. Decrease the chamber's pressure at a rate of 15 kPa/hr to 80 kPa.
4. Maintain a condition of 45°C and 80 kPa for 8 hours. (R4-8 [74])
5. Decrease the chamber's temperature at a rate of 5°C/hr to 35°C.
6. Decrease the chamber's pressure at a rate of 15 kPa/hr to 60 kPa.
7. Maintain a condition of 35°C and 60 kPa for 8 hours. (R4-9 [136])
8. Increase the chamber's pressure at a rate of 15 kPa/hr to ambient.
9. Decrease the chamber's temperature at a rate of 5°C/hr to 25°C.
10. Test is complete.

5.1.4 Temperature Margin Determination

This section presents a test method to determine the effect of temperature in excess of the expected operating range. Although a fan failure may occur for 96 hours, an 8-hour period is used for testing. The equipment is operating at the start of the test and the effects of elevated temperature on the equipment are reported. This test is not needed if an operating temperature and humidity test used an elevated temperature that enveloped the test conditions below.

Test Sequence - Monitor the chamber's ambient temperature continuously during the test. Thermal stability is assumed to be achieved after 4 hours.

1. Operate the equipment at an ambient temperature of 23°C (73°F) and RH level 50% for a period of 4 hours to verify that equipment has achieved operational stability.
2. Increase the chamber's temperature at a rate of 30°C/hr (54°F/hr) to 50°C (122°F) for frame-level equipment, 55°C (131°F) for shelf-level. For frame-level equipment, attain less than a 32% RH level by the time the target temperature is attained. For shelf-level equipment, attain less than a 25% RH level by the time the target temperature is attained.
3. Maintain this condition for 1 hour.
4. Increase the chamber temperature 5°C (9°F) at a rate of 30°C/hr (54°F/hr).
5. Maintain this condition for 1 hour. Note any performance changes in the equipment.

6. If equipment is still operating, increase the chamber temperature an additional 5°C (9°F) at a rate of 30°C/hr (54°F/hr).
7. Maintain this condition for 1 hour. Note any performance changes in the equipment.

Report the equipment's response to the elevated temperature. Report the threshold temperature for deterioration of functional performance and/or equipment shutdown.

NOTE: Testing in excess of 10°C (18°F) above the short-term limits is not necessary, even if no effect is observed.

5.1.5 Operation with Fan Failure

A variant of thermal testing is used to verify that equipment can operate with a single fan failure. When multiple fans are present in the system, the fan failure shall be applied to the fan which is likely to cause the greatest temperature rise in the system. This may be determined from manufacturer supplied data. If this cannot be determined prior to testing, then multiple fan failure tests will be required.

Test Sequence - Monitor the chamber's ambient temperature continuously during the test. Thermal stability is assumed to be achieved after 4 hours.

1. Operate the equipment at an ambient temperature of 40°C (104°F) and RH level 50% for a minimum period of 4 hours to verify that equipment has achieved operational stability.
2. De-energize the fan under consideration.
3. Maintain this condition for 8 hours, and record functional observations.
4. Stop the test if no other fans are to be tested. Otherwise, re-energize the fan under consideration.
5. Repeat Steps 2 through 4 for each additional fan to be tested.

5.1.6 Surface Temperature Test Procedures

Equipment verification tests shall be performed on network equipment to confirm exposed exterior surfaces are in conformance to temperature limits stated in this document. The equipment shall be subjected to temperature measurements using equipment that can detect emitted energies from a material's surface. Either infrared thermometers or contact sensors may be used.

5.1.6.1 Infrared Measurement Equipment

Infrared thermal measurement equipment shall have adjustment for emissivity between 0.1 to 1.0 to compensate for thermal emittance of the material being measured. The equipment shall be calibrated to the appropriate emissivity settings for materials being measured. If the emissivity value of the material is not known, follow the instrument manufacturer's instructions to determine the appropriate setting.

The surface to be measured by the infrared thermometer shall be approximately 0.5 inch diameter spot on the target surface. The measurement tool shall be positioned at appropriate distance from equipment for the 0.5 inch diameter spot based on the infrared thermometer's distance-to-spot ratio (field of view). For target surfaces smaller than the 0.5 inch diameter measuring spot, the infrared spot should be reduced so the target area is at least twice as large as the spot size.

5.1.6.2 Contact Measurement Equipment

Contact Sensor measurement methods may include the use of Resistance Temperature Detectors (RTDs), Thermistors, Thermocouples, as well as Solid State PN Junction devices. For best possible accuracy, platinum RTD Class A, band 5 devices or equivalent are recommended.

Devices used in the contact method shall be attached to the measured surfaces with thermally conductive adhesive but not electrically conductive paste. Apply measurement sensor to the immediate surface to be measured in an appropriate manner such that any gradients that may result from placement of the sensor are minimized. "Peak heat" location(s) on an exposed surface should be determined prior to using either infrared methods, hand held probes, or similar devices. Once a "Peak heat" location is identified, the temperature measuring sensor shall be placed as near to that location as possible.

5.1.6.3 Equipment Evaluation Procedures

Measurements shall be made in an environment where the external airflow cannot have an appreciable effect on the test results.

The network equipment to be measured for surface temperature shall be operating and allowed to run at room temperature for 24 hours (or when thermal stabilization has been achieved) prior to making measurements.

NOTE: For these measurements, thermal stabilization is defined as a maximum variation in surface temperature of 1°C over a 1-hour period.

1. Measurements should be made at room temperature and normalized to 23°C. Corrections should be small so that the operating state of the equipment, including fan speed, would not change between the measured condition and 23°C.
2. Record the location of the maximum temperature and any temperatures over 48°C on the front surface of the equipment.
3. Record the location of the maximum temperature and any temperatures over 48°C on surfaces other than the front face of the equipment to which a person may be exposed.
4. Describe the measured surfaces by part description. State whether the part is a short-term or long-term exposure surface and describe the location.
5. Assess conformance to **O4-21 [79]** and **R4-22 [159]** .

5.2 Fire Test Methods

The testing and reporting methods contained in **ANSI T1.319-2002** shall be utilized for determining conformance to [Section 4.2.1, “Fire-Resistance Rationale,”](#) of this document. The following clarifications and deviations shall be utilized.

5.2.1 Testing Clarification - Circuit Board Removal

For each compartment in a frame- or shelf-level test, consisting of different circuit board types, only one burn would be performed. That burn would be judged by the test lab (with input from the customer as needed) to be the worst case fuel load burn of one of the three cases below.

5.2.1.1 Case 1 - No Mezzanine Cards

- For each trial in equipment comprised of VERTICALLY oriented circuit boards, one (1) Printed Wiring Board (PWB) shall be removed and the line burner inserted into the empty slot.
- The line burner shall be inserted into the slot in the plane of the removed PWB, with the burner holes facing in the same plane as the removed PWB. See [Figure 5-6](#).
- Only the PWB should be removed. Any structural items such as plastic card guides or card carriers attached to the PWB should be left in their original position.
- If the faceplate is metal, it can be substituted with metal foil or similar material. The airflow of the slot shall not be changed by the removal of the faceplate.
- Metal barriers (sometimes called firestops) shall remain in their original positions.

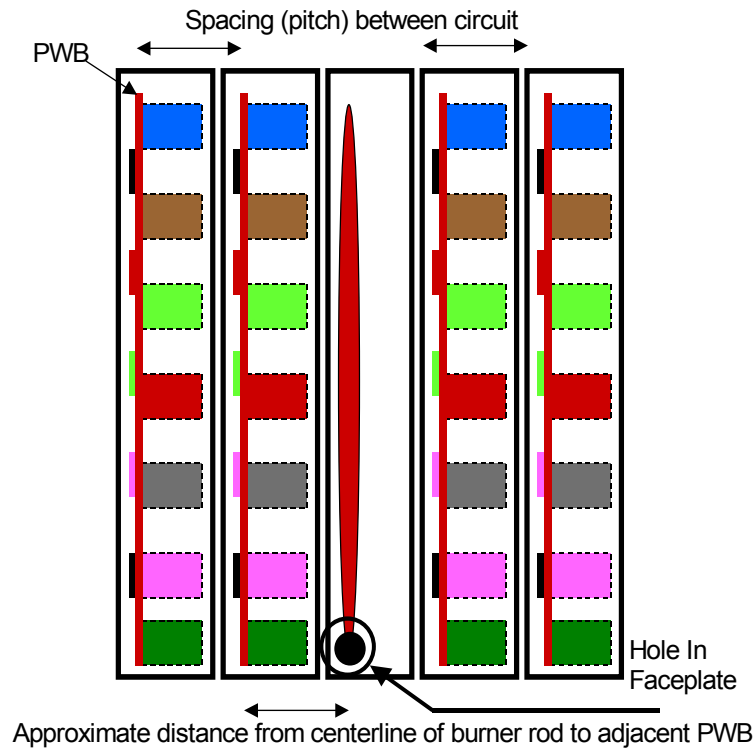
Figure 5-6 Card Removed and Burner Inserted in Plane of PWB

5.2.1.2 Case 2 - Mezzanine Card

- If the PWB has a mezzanine card or cards, they shall be left in place within the system. [Mezzanine cards are defined to be PWBs that are attached to a main or parent (mother) PWB, and as such rely on the parent PWB for physical installation in the system. Mezzanine cards connect to the backplane via the parent board.] The line burner shall be inserted into the slot in the plane of the removed PWB, with the burner holes facing in the same plane as the removed PWB. See [Figure 5-7, “Parent PWB Removed and Burner Inserted - Mezzanine Card Left in Place.”](#)
- If the faceplate is metal, it can be substituted with metal foil or similar material. The airflow of the slot shall not be changed by the removal of the faceplate.
- Metal barriers (sometimes called firestops) shall remain in their original positions.

Figure 5-7 Parent PWB Removed and Burner Inserted - Mezzanine Card Left in Place

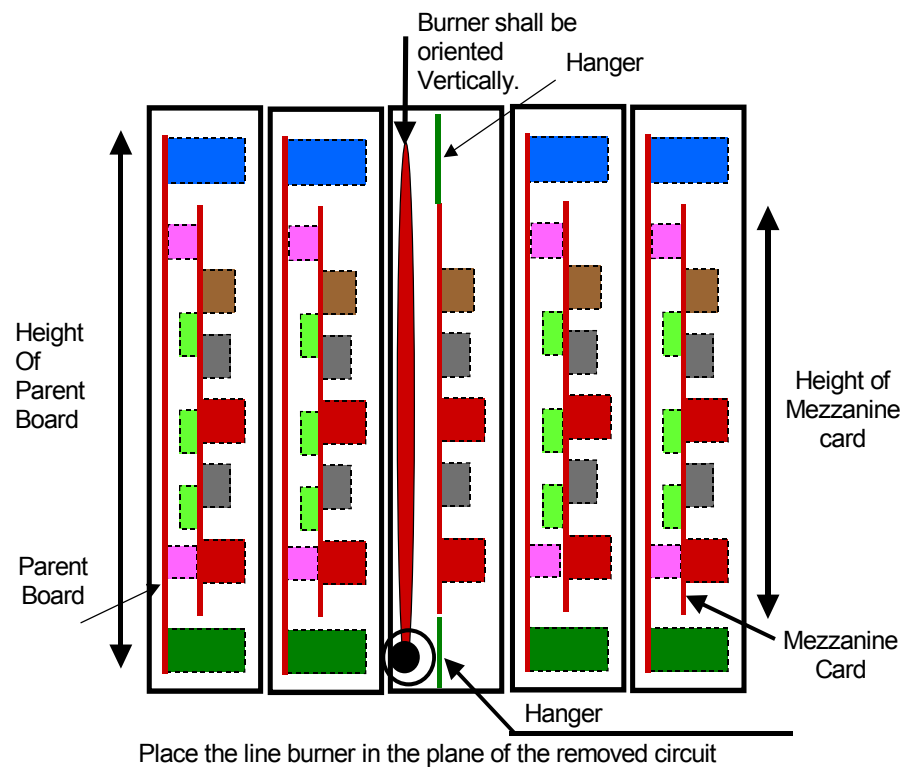

5.2.1.3 Case 3 - Larger or Multiple Mezzanine Cards

If a PWB contains a mezzanine card(s) with a total area equal to or greater than 50% the area of the parent PWB, then a burn in the mezzanine card area may be appropriate. If such a burn is deemed appropriate, perform the following:

- Remove a mezzanine card and scale the line burner to the height and depth of the mezzanine card per **ANSI T1.319-2003**.
- Place the line burner in the same plane as the removed mezzanine card. See [Figure 5-8, "Mezzanine Card Removed and Burner Inserted."](#)
- If multiple mezzanine cards are located front to back in one plane, remove ALL the mezzanine cards in the plane and scale the burner to the height of the largest card.
- If multiple mezzanine cards are located top and bottom in the same plane, consider removing the bottom one and scaling the burner to the height and depth of this card. If the bottom card is a small fuel load compared to other mezzanine cards, consider that the other card locations may be better candidates for testing, as they may represent the worst case for firespread.

- In all cases, leave the parent PWB and other structural items and additional mezzanine cards, if any, in place.

Figure 5-8 Mezzanine Card Removed and Burner Inserted

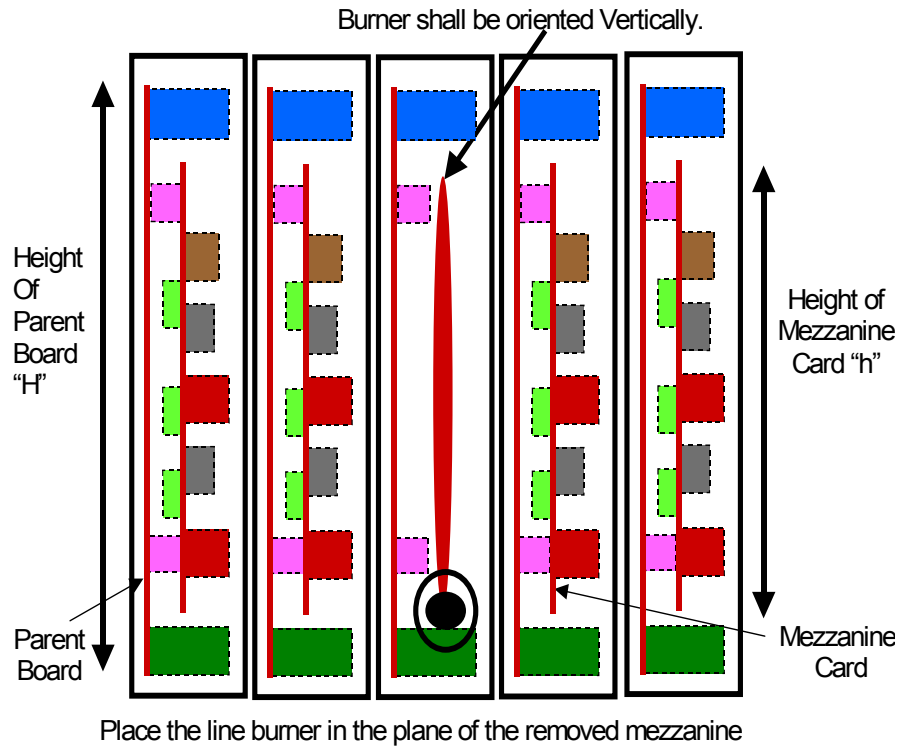

5.2.2 ANSI T1.319-2003 Test Deviation - Fan Powering Options

Where the equipment being tested contains cooling fans, the fans shall be operated during the test. If the fans are variable speed, the fans must be powered via the normal powering path, including any fan speed control circuitry. Sufficient power shall be supplied to allow the fans to operate as intended. If the circuit card removed is part of a power supply, any fans that are normally powered only by that supply shall not be powered during the test. Other than fans and their control, no other components need to be powered.

If the air movement within the equipment is sufficient to extinguish the burner prematurely, **ANSI T1.319-2002** prescribes a protocol of adjustments to the test variables of burner location and initial pilot flow. If after using methods in **ANSI T1.319-2002**, the air movement within the equipment is still sufficient to extinguish the burner prematurely, this observation shall be noted. The testing shall continue by applying the additional steps below to achieve complete burner operation:

1. Configure the line burner per the test flow profile developed per **ANSI T1.319-2002**, Section 5.1.4.3.

2. Insert the line burner into the EUT while reducing the airflow through the EUT until ignition is maintained. The airflow reduction can be accomplished by a combination of methods such as obstruction of the air inlet and/or diversion and/or reduction of the nominal EUT airflow characteristics.
3. It may be necessary to further adjust the test variables of location and pilot flow in combination with the airflow in order to achieve successful burner operation.
4. Once successful burner operation is achieved, make no further adjustments to the airflow. Proceed with the testing as normal and continue the test to completion. Airflow may or may not be returned to normal setting after the burner has completed the profile.

The method of achieving burner operation shall be noted in the test documentation including locations, methane flow rates, and departures from nominal EUT airflow rates.

5.2.3 Telcordia Needle Flame Test

5.2.3.1 Application to Individual Components

This test determines whether structural or energizable components (tested in a non-energized state) can resist flame spread. The components are considered flame-spread resistant if after one application of the needle flame (as described by **IEC 695-2-2** and applied in accordance with **Table 5-1**) the test sample does not ignite, or any resulting flames extinguish within 30 seconds of removing the needle flame, and any plastic drippings do not ignite a piece of paper placed 50 mm (≈ 2 in) below the test sample location.

Test three (3) samples to ensure repeatability of results.

Table 5-1 Application Criteria for Needle Flame Test

Volume of Component (mm ³)	Flame Application Time (seconds)
< 250	5
250 to < 500	10
500 to < 1750	20
≥ 1750	30

5.2.3.2 In-Situ Application to Individual Components

This test determines whether structural or energizable components (tested in a non-energized state) in situ on a circuit pack, can resist flame spread. The components are considered flame-spread resistant if on removal of the needle flame, the resident flame condition does not spread to adjacent items. This constitutes evidence that as used, the item is fire resistant in terms of **Section 4.2.3.1, “Material/Components Fire-Resistance Criteria.”** The test shall be made on 3 test specimens per configuration to ensure the repeatability of the results.

5.2.4 Guidelines for Retesting to Address Product Changes

After an assembly has been tested, it need not be re-tested to these criteria for fire resistance as long as any substitution of structural materials, electronic components or, wire and cable by replacements meets the requirements of [Section 4.2, “Fire Resistance,”](#) and the equipment does not significantly increase in fuel load or change in configuration.

The following are general guidelines that can be utilized in determining the need for retesting:

1. Analyze the changes to determine if a substantive change has been made. This may involve closely reviewing the old and new subassemblies as well as reviewing the original test report and test video.
2. If the equipment was originally exempted from a burn test and no longer meets the criteria for an exemption, it must undergo an appropriate burn test.
3. If the equipment was originally exempted and still complies with an exemption, document why it still complies or how it now complies in a test report. No further assessment is necessary unless the end customer requires a burn test.
4. If the equipment was originally burn tested, use the information obtained in Step 1 to determine if the results from the burn test could reasonably be affected in any substantive manner that would change the net conformance results of the test. If the results could reasonably be affected and change the conformance status, the equipment shall be subjected to an appropriate burn test. If the results could not reasonably be affected and change the conformance status, a report shall be prepared that includes the engineering rationale as to why the equipment would still be expected to conform to the appropriate criteria.
5. Generally, if the equipment being evaluated is a subassembly for existing systems, it shall be considered compliant if its nominal Printed Circuit Board (PCB) height has not increased, its printed circuit board density has not increased (i.e., no added daughter cards), and its PCB materials remain consistent with subassemblies originally approved. The report shall explain why the subassembly would not be expected to change the conformance status of a system based on its equivalence to previous subassemblies.
6. If an equipment subassembly does change substantially, and the changes could reasonably result in changing the conformance status of a system, it shall be subjected to the assembly burn test installed in a system.
7. In some cases, it may be useful for the equipment to be subjected to the subassembly test in **ANST T1.319-2002** as an analysis tool. This can be helpful with some systems. It should be noted, there are no conformance criteria for the subassembly tests, as the actual effect of a system enclosure will impact the results. The results of the subassembly test shall be reported without a claim of conformance or non-conformance.

5.2.5 Test Reporting - Additions

Written test reports shall verify that the stated test requirements have been met. Refer to the test report format of **ANSI T1.319-2002**, Section 11. In addition, include peak heat release, average heat release, quantitative smoke measurement data, and video records (visual and thermal image) as detailed below.

Heat Release Measurement: Include a description of the peak rate of heat release, its time of occurrence, and average heat release for the duration of the test. These measurements should be made using oxygen depletion calorimetry.

Smoke Measurement: Include a description of the first occurrence of smoke and major qualitative changes in physical appearance as they occur during the test. Smoke may be expressed quantitatively by rate of smoke release (a parameter calculated based on exhaust flow rate, duct diameter, and optical density) and qualitatively in relative terms of volume, visibility, color, buoyancy, etc. Quantitative smoke measurements should be made in accordance with **ASTM D 6216-03**, *Practice for Opacity Monitor Manufacturers to Certify Conformance with Design and Performance Specifications*. A graphic plot of smoke obscuration as a function of time shall be provided with the test results. Smoke measurements records should demonstrate performance relative to the smoke criteria of **Section 4.2.2.3**, “Smoke and Self-Extinguishment Criteria.”

Video Records: Color video recordings (standard image) of all firespread tests shall be included in the report documentation. The standard image shall include at least two perspectives: typically one view facing the side of the EUT from which the line burner is inserted, called the “front” view, and another view facing the EUT opposite the line burner entry, called the “rear” view. The standard image shall display the full perspective of the EUT, the FLIIM/SLIIM, and both sides of the EUT. The standard image video must display at least 50 mm of ground in front of a frame-level EUT and 100 mm below a shelf-level EUT. The height of all camera mountings shall be between the center and top of the EUT and approximately perpendicular to the front or rear surface. The resolution of the standard images must be sharp enough to identify the EUT and the test setup. Zooming and panning to identify the EUT and the test setup prior to testing are permitted.

A thermal image video camera shall record the test from the front view and be aligned closely to the line-of-sight of the front color video camera. The thermal image must display the entire front view of the EUT surface, plus at least 50 mm of clearance around the EUT. Resolution of the thermal image video must be sharp enough to display fire and heat propagation within the EUT.

The firespread test videos shall record all trials in chronological order and shall match the descriptive text in the written report. The final recordings shall include a split screen display of the front view standard image and the thermal image, and a separate recording of the rear view. (Do not combine more than 2 views on a single video image.) A time display showing minutes and seconds from the start of the burner profile shall be provided in all views and shall not obscure the fire test.

5.3 Handling Test Methods

The test methods in this section determine whether equipment can withstand the shock associated with transportation and installation as specified in [Section 4.3, “Equipment Handling Criteria.”](#) The equipment does not operate during any of the tests. However, the equipment is tested for operability before and after each test.

General Testing Requirements

The criteria for assessing functionality shall be included in a written test plan. The criteria depend on the service provided by the equipment being tested, and are determined by applying appropriate Telcordia generic requirements, or, if none exists, by the supplier’s or purchaser’s own performance specifications.

Tolerances

Unless otherwise specified, the drop height shall be maintained within ± 20 mm or 10% of the drop height, whichever is smaller.

Ambient Temperature

Unless otherwise specified, all tests shall be performed at ambient room temperature, defined as a temperature between 20°C (68°F) and 30°C (86°F).

Drop Surface

A smooth, level, concrete surface (or similarly unyielding surface) shall be used to perform the shock tests.

Apparatus

In conducting the free-fall drops, any suitable apparatus may be used that conforms to the following requirements:

- Permits the container to be placed in a position prior to the release that will assure free unobstructed fall to impact the container at the orientation and the direction required.
- Permits accurate and convenient control of the drop height
- Uses a lifting device that will not damage the container
- Provides an instantaneous release mechanism that will not damage the container.

It may be possible to drop the smaller packages (< 25 kg) from a hand-held position. Where a lifting-release device is used, it should not, on release, impart rotational or sideward forces to the equipment package.

Test Data

The following information shall be recorded:

- Gross weight of the container
- Weight of the equipment
- Type of packaging (palletized, corrugated box, etc.)
- Drop height
- Report and photograph all visible damage

- Report if packaging was replaced during the testing
- Report if toppling restraints were used/required.

5.3.1 Handling Drop Tests - Packaged Equipment

Category A Container

Test Procedure:

1. Perform the test on normally packaged equipment units. The Equipment Under Test (EUT) shall be dropped from the height specified in [Table 4-7, "Category A Container Packaged Equipment Shock Criteria."](#)
2. The packaged equipment is dropped once on each of the following, see [Figure 5-9](#):
 - Surface S1, S2, S3, S4, S5, S6 (every surface)
 - Edge E2-3, E2-6, E5-3
 - Corner C1-2-6, C1-4-6, C2-3-5, C2-3-6
3. For corner drops, orient the EUT so that a straight line drawn through the struck corner and the package's geometric center is approximately perpendicular to the impact surface (see [Figure 5-10](#)).
4. Allow 1 minute between drops for the cushioning to recover its shape.
5. If the container/package is visibly damaged or if the equipment unit sounds damaged after a drop, stop the testing and inspect the equipment for damage and operability. If the packaging is significantly damaged, it may be replaced. However all packaging replacement must be reported.
6. Continue the testing until all drops have been completed.

Figure 5-9 Drop Surfaces for Category A Container

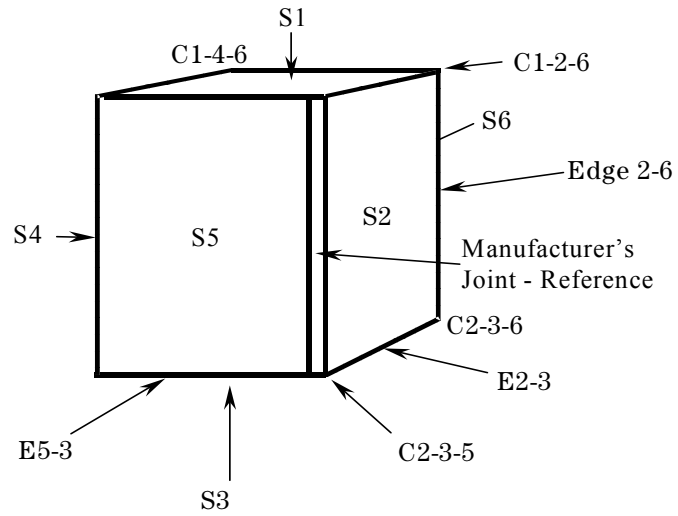
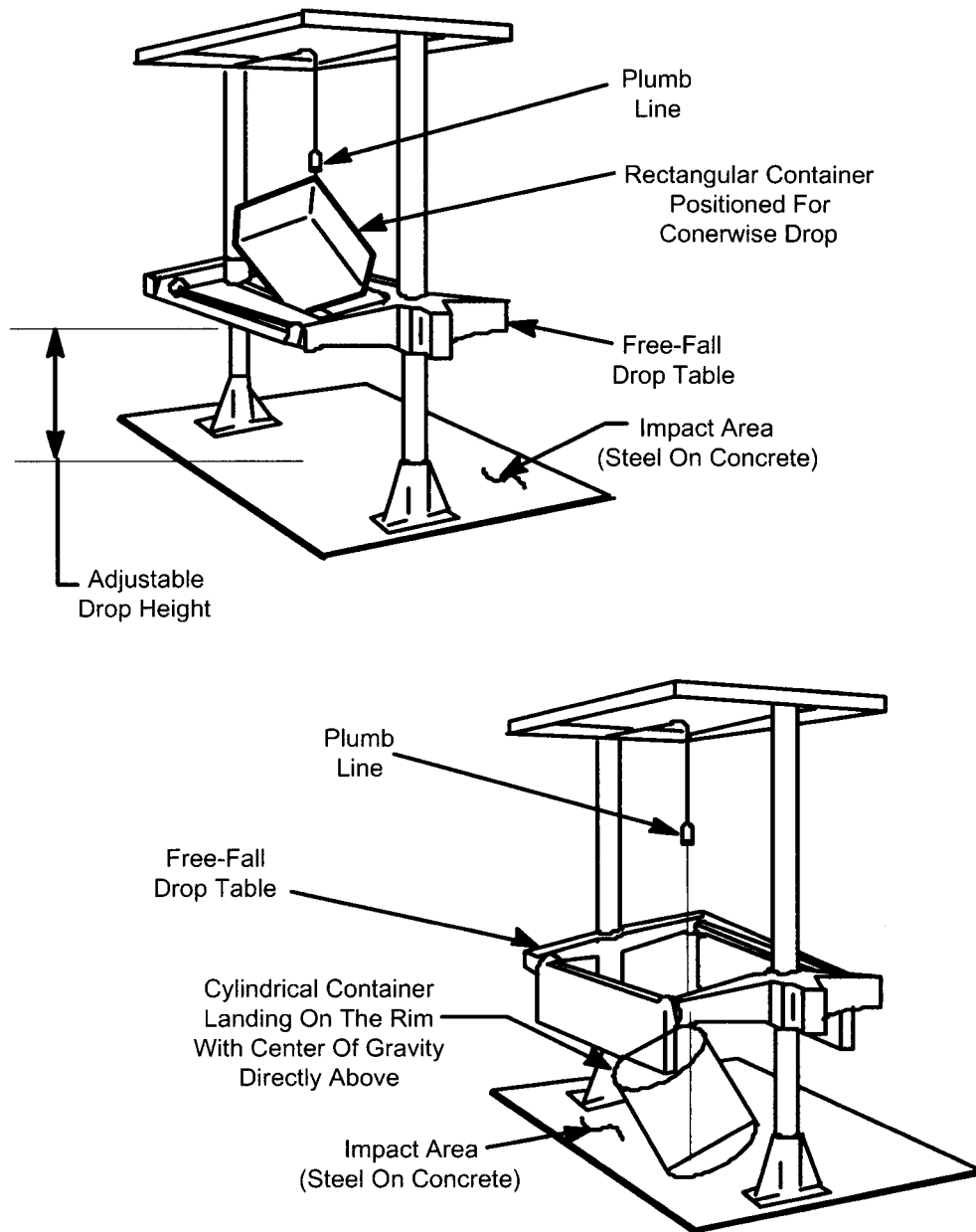

Figure 5-10 Test Set-Up for Category A Container



Category B Container

Test Procedure:

1. Perform the test on normally packaged equipment units. The EUT shall be dropped from the height and on the surfaces specified in [Table 4-8, “Category B Container Packaged Equipment Shock Criteria.”](#)
2. Handle the EUT with any convenient equipment (e.g., forklift truck, hoist, or block and tackle).
3. Place the EUT on its normal rest surface.
4. The EUT is subjected to 2 drops to the normal rest surface (see [Figure 5-11](#)):
5. Raise the EUT to the prescribed height. See [Figure 5-12 \(a\) and \(b\)](#). The test area must be sufficiently large such that the EUT is not precluded from toppling over.
6. For EUT designed with handling hardware (e.g., eye bolts, etc.), the unit should be supported from it and allowed to assume the resultant position, as shown in [Figure 5-12 \(a\)](#). Because the rest face may not be horizontal, the prescribed drop height should be measured from the lowest point on the equipment to the floor. The EUT should be dropped twice from this position.

Figure 5-11 Drop Surface for Category B Container

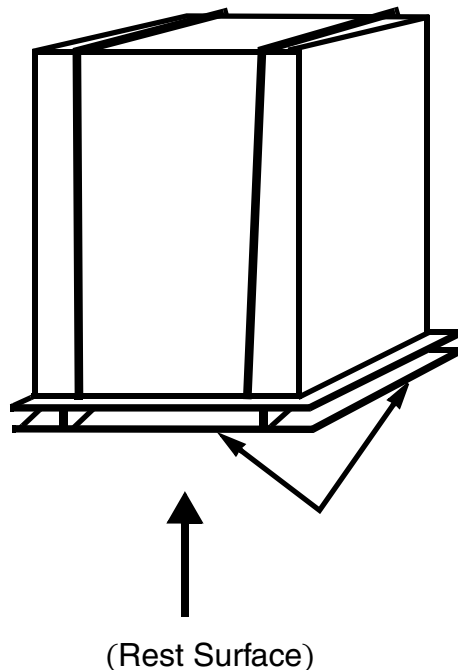
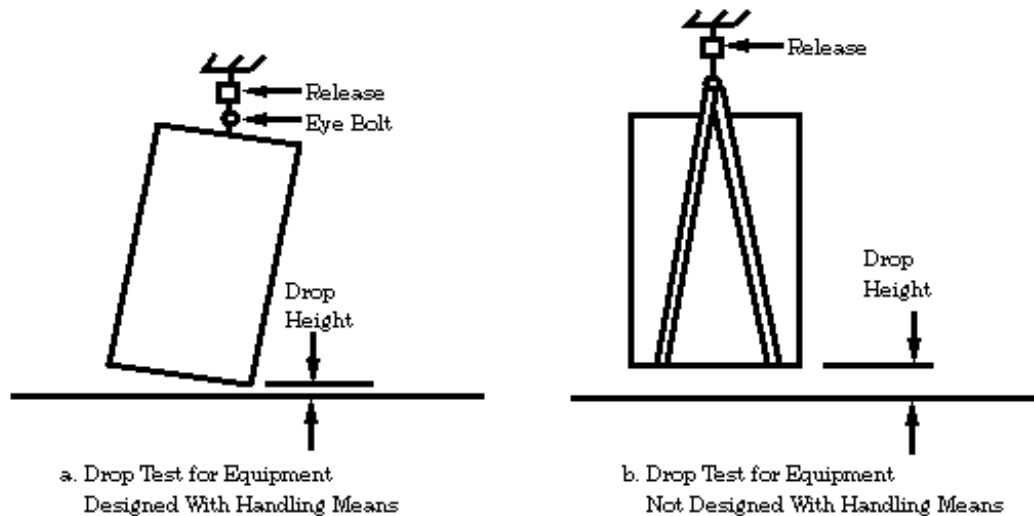

Figure 5-12 Category B Container - Equipment Handling Drops



5.3.2 Unpackaged Equipment Drop Tests

The unpackaged (installation) handling tests consist of free-fall drops, edge drops, and corner drops. The drops may be conducted in the following manner:

Test Procedure—Circuit Packs (free-fall drops):

1. Perform the test on an unpackaged circuit pack. Drop the circuit pack from a height specified in Table 4-9, “Unpackaged Equipment Shock Criteria.” All drops should be onto a smooth, level concrete floor (or similarly unyielding surface).
2. The EUT is dropped once on each of following (see Figure 5-13):

Rest Surface	S1, S2
Corner	C1 (front latch/handle) C2 (backplane connector)

3. It is possible to drop circuit packs from a hand-held position. Where a lifting-release device is used, it should not, on release, impart rotational or sideward forces to the equipment.
4. For corner drops, hold the circuit pack by the opposite corner and allow the pack to assume a resultant position. The pack is dropped from this position onto the impacted corner. Repeat for two (2) corners.

Figure 5-13 Drop Surfaces for Circuit Pack

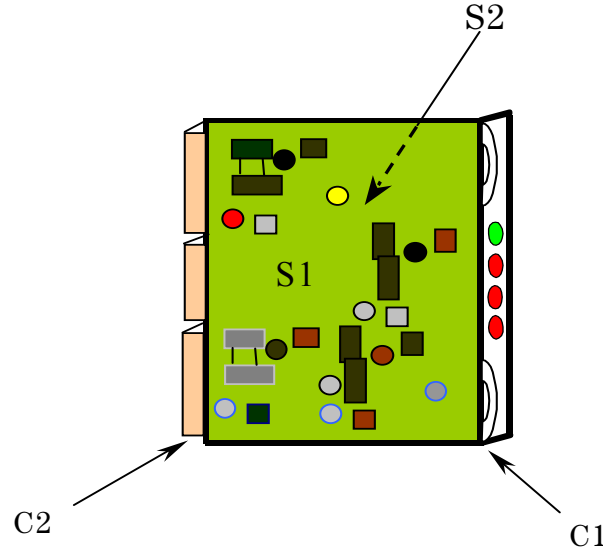

Test Procedure—Other Equipment Weighing Less Than 25 kg (free-fall drops):

1. Perform the test on an unpackaged equipment unit. Drop the equipment from a height specified in [Table 4-9, “Unpackaged Equipment Shock Criteria.”](#) All drops should be onto a smooth, level concrete floor (or similarly unyielding surface).
2. The EUT is subject to the following free-fall drops (see [Figure 5-14](#)):

Normal Rest Surface	S1
Corner of Rest Surface	C1, C2
Edge of Rest Surface	E1, E3
3. It may be possible to drop smaller units from a hand-held position. Where a lifting-release device is used, it should not, on release, impart rotational or sideward forces to the equipment.
4. For corner/edge drops, orient the equipment so that a straight line drawn through the struck corner/edge and equipment's geometric center is approximately perpendicular to the impact surface.

Figure 5-14 Drop Surfaces for Equipment Less Than 25 kg

Front-Left Side (Reference)

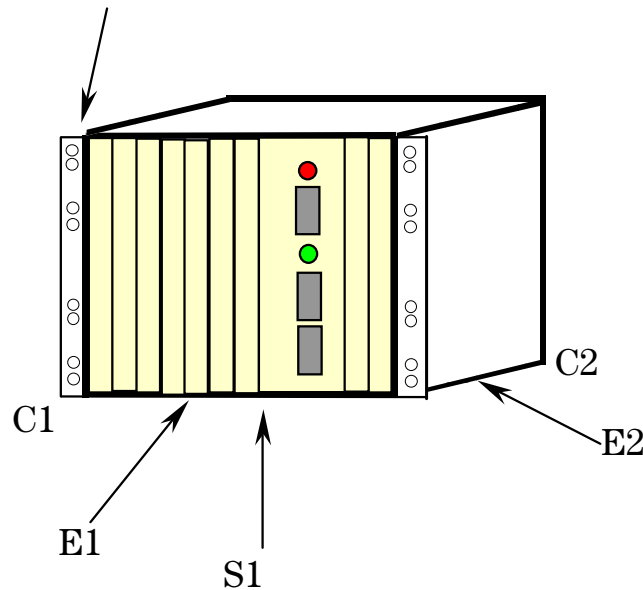

Test Procedure — Other Equipment Weighing More Than 25 kg:

1. Perform the tests on an unpackaged equipment unit. All drops should be onto a smooth, level concrete floor (or similarly unyielding surface).
2. The EUT is subject to the following drops (see [Figure 5-15](#)):

Normal Rest Surface	S1
Edge of Rest Surface	E1, E3 [Rotational Drops Figure 5-16 (a)]
Corner of Rest Surface	C1, C2 [Rotational Drops Figure 5-16 (b)].
3. For equipment that is not designed with handling hardware, provide a support-release device and drop the unit once on the normal rest face from the height specified in [Table 4-9, “Unpackaged Equipment Shock Criteria.”](#) For this test, the rest face should be horizontal at the time of release.
4. Drop the equipment once on each specified edge and corner adjacent to the rest surface from the heights specified in [Table 4-9](#). As [Figure 5-16 \(a\)](#) and [\(b\)](#) shows, one edge or corner of the rest face should be supported at a height sufficient to ensure that there is no intermediate support for the equipment when the opposite edge or corner is dropped.

Figure 5-15 Drop Surfaces for Equipment More Than 25 kg

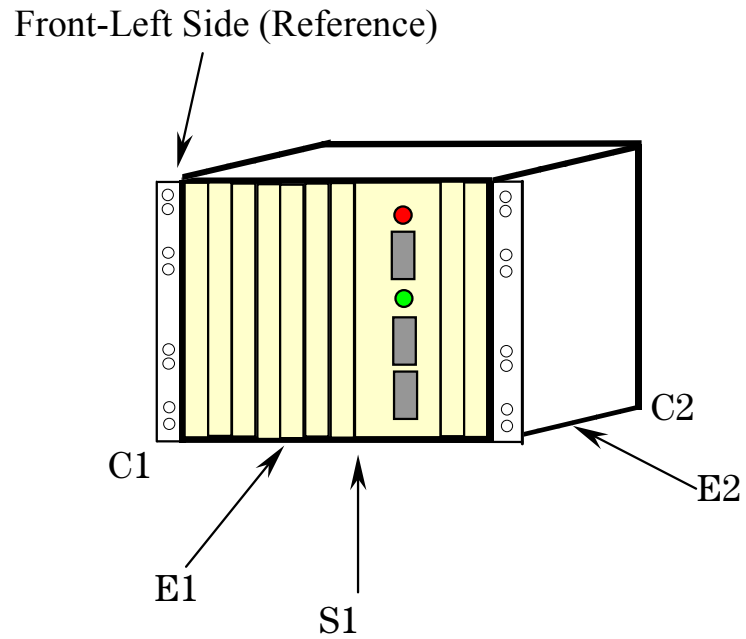
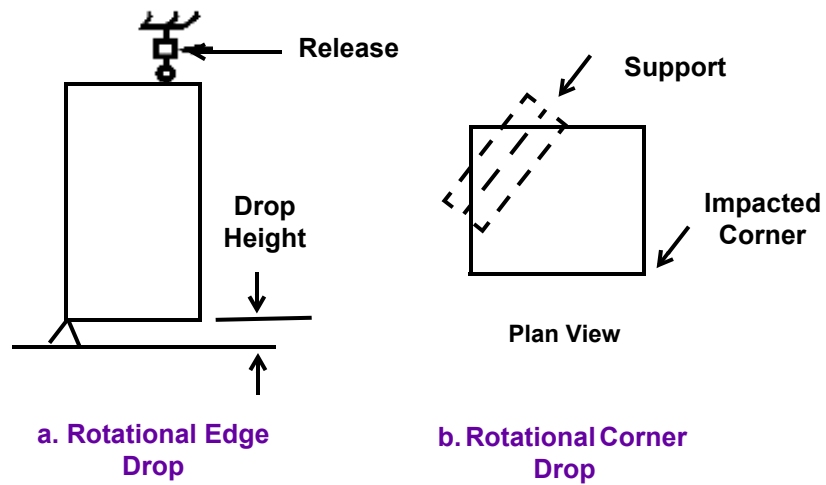

Figure 5-16 Unpackaged Rotational Drops for Equipment More Than 25 kg



5.4 Earthquake, Office Vibration, and Transportation Vibration Test Methods

This section provides test methods for the criteria specified in [Section 4.4](#), “Earthquake, Office Vibration, and Transportation Vibration.”

- [Section 5.4.1](#), “Earthquake Test Methods,” provides the earthquake test method.
- [Section 5.4.2](#), “Office Vibration Test Procedure,” provides the office vibration test method.
- [Section 5.4.3](#), “Transportation Vibration—Packaged Equipment,” provides the transportation vibration test method.

5.4.1 Earthquake Test Methods

The designated network facility location for the equipment will determine the severity of the test. For example, equipment designated for installation in Earthquake Risk Zone 4 is tested at the highest acceleration level. Equipment that will not be installed in Earthquake Risk Zone 4 may be tested to the reduced acceleration levels of the applicable zone.

Telecommunications equipment is earthquake tested using a prescribed waveform. The acceleration-time history waveform, VERTEQII, shown in [Figure 5-17](#), has been synthesized from several typical earthquakes and for different building and soil site conditions. The test procedure subjects equipment to follow the prescribed motion of the synthesized waveform by means of a shaker table.

Shaking is applied to the equipment being tested in each of the three (3) orthogonal directions of the framework. This simulates conditions that would be encountered in service when building floors apply earthquake motions to the equipment.

Horizontal static pull tests on framework may be performed before waveform testing. Static pull tests provide an approximation of framework strength and stiffness characteristics.

Figure 5-17 Earthquake Synthesized Waveform - VERTEQII- Zone 4

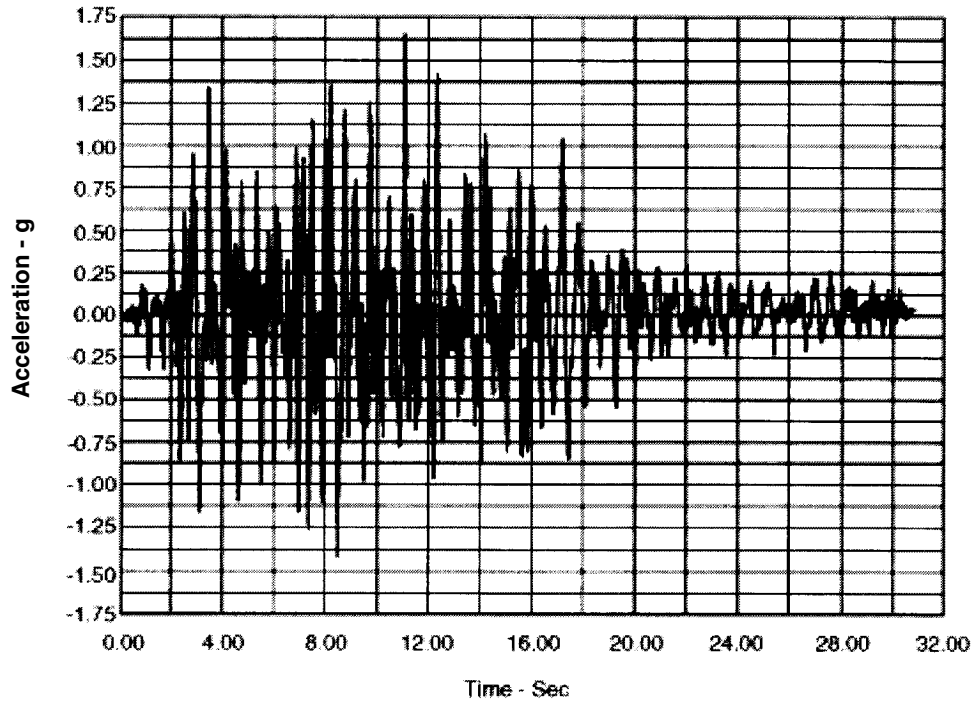
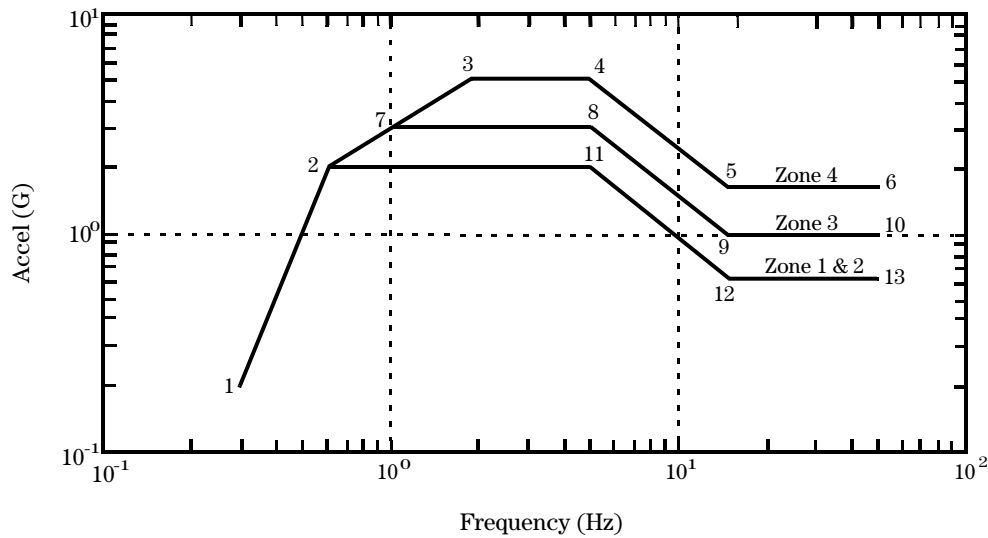

Figure 5-18 Required Response Spectra



Coordinate Point	Frequency (Hz)	Values for Upper Floor Acceleration (g)	Coordinate Point	Frequency (Hz)	Values for Upper Floor Acceleration (g)
Zones 1 and 2			Zone 4		
1	0.3	0.2	1	0.3	0.2
2	0.6	2.0	2	0.6	2.0
11	5.0	2.0	3	2.0	5.0
12	15.0	0.6	4	5.0	5.0
13	50.0	0.6	5	15.0	1.6
Zone 3			6	50.0	1.6
1	0.3	0.2			
2	0.6	2.0			
7	1.0	3.0			
8	5.0	3.0			
9	15.0	1.0			
10	50.0	1.0			

5.4.1.1 Test Plan

A test plan shall be prepared before testing begins. The test plan shall include the following:

- A test schedule outlining the order of the tests, and Earthquake Risk Zone designated for testing

- The physical equipment configuration proposed for testing and the technical rationale for this configuration
- Equipment details showing individual shelf weights, dimensions, and locations
- Installation guidelines for the equipment
- Framework dimensions and weight
- Dimensions, arrangements, and specifications of framework anchoring hardware
- Proposed weight to simulate overhead cable and justification for it
- Electrical functionality tests to be performed and acceptance criteria
- Other details necessary to fully describe the testing.

5.4.1.2 Laboratory Equipment

Shaker Table

Shaker tables used for testing shall meet the following requirements:

- The usable peak-to-peak stroke of the shaker shall be a minimum of 250 mm (*10 in*).
- The minimum frequency range of the shaker table shall be from 1.0 to 100 Hz.
- The shaker table shall be capable of achieving a peak sinusoidal velocity of 1 m/sec (*40 in/sec*).
- When reproducing the Telcordia waveform, the shaker table's analyzed acceleration, known as the Test Response Spectrum (TRS), must meet or exceed the Required Response Spectrum (RRS) shown in [Figure 5-18](#) for the applicable Earthquake Risk Zone in the range from 1.0 to 50 Hz. The TRS is derived from the shaker table acceleration using an assumed damping level of 2%.

Waveform

Waveforms are available from Telcordia in electronic format. There are three (3) waveforms: one for Zones 1 and 2 testing, one for Zone 3 testing, and one for Zone 4 testing. For information and copies of the waveforms, please contact:

- Telcordia at www.telcordia.com, or phone + 1.732.699.5490.

Use the appropriate waveform for the Earthquake Zone test to be performed. [Figure 5-17](#) shows a plot of the Zone 4 Waveform Earthquake VERTEQII.

A transfer function must be made to account for each shaker table's unique response. The transfer function relates the shaker table's input (typically in displacement) to the shaker table's output in g's. For any shaker table, a transfer function can be found by dividing the table's output by the table's input (in the FFT domain). The inverse of this transfer function shall be multiplied by the appropriate waveform (in the FFT domain). The resulting FFT domain drive signal is then converted for use in the time domain. This process shall be employed to generate the drive signal for each test run of the shaker table.

The cutoff of the high pass filter on the drive signal shall not exceed 0.20 Hz. The cutoff of the low pass filter on the drive signal shall not be below 50 Hz.

Accelerometers

Accelerometers shall have a minimum dynamic range of 0.5 to 100 Hz. A minimum of three (3) accelerometers is required.

Response Spectrum Analyzer

The TRS is generated from the shaker table acceleration data via a Response Spectrum Analyzer, using 2% damping. The reproduction of the Telcordia waveforms shall be verified by analyzing the TRS at 6th octave (logarithmically spaced) frequencies from 0.5 to 50 Hz. Table 5-2 lists the frequencies. If using a digital analyzer, the digitizing rate shall be ≥ 200 Hz with a total storage capacity of ≥ 30 seconds, real time.

Table 5-2 Response Spectrum Analyzer Frequencies

0.5000 Hz	1.7818 Hz	6.3496 Hz	22.6274 Hz
0.5612 Hz	2.0000 Hz	7.1272 Hz	25.3984 Hz
0.6300 Hz	2.2449 Hz	8.0000 Hz	28.5088 Hz
0.7071 Hz	2.5198 Hz	8.9797 Hz	32.0000 Hz
0.7937 Hz	2.8284 Hz	10.0794 Hz	35.9188 Hz
0.8909 Hz	3.1748 Hz	11.3137 Hz	40.3175 Hz
1.0000 Hz	3.5636 Hz	12.6992 Hz	45.2548 Hz
1.1225 Hz	4.0000 Hz	14.2544 Hz	50.7968 Hz
1,2599 Hz	4.4898 Hz	16.0000 Hz	
1.4142 Hz	5.0397 Hz	17.9594 Hz	
1.5874 Hz	5.6569 Hz	20.1587 Hz	

Deflection Measurement Equipment

A method of measuring the deflection at the top of the framework relative to its base shall be provided. A Linear Variable Displacement Transducer (LVDT) may be used for this purpose. The deflection data shall be included in the test report.

Video Equipment

The waveform tests shall be video taped. The video tapes shall clearly show the front view of the frame and enable the motion of the top of the framework relative to the base to be observed. The video tapes should include time references in increments of 0.1 of a second for analysis.

Data Acquisition Equipment

It is required to digitize the output of each accelerometer and deflection measurement device at a sample rate of 200 Hz, or higher, and record the data as an electronic file. The reference time for all test data shall be common to allow for analysis.

Anchor Load Measurement Equipment

If the concrete slab and anchors are omitted from the frame-level test configuration, the peak load of the substitute fasteners shall be measured during synthesized waveform testing. This can be accomplished using “strain bolts” or “load-cell washers.” The instruments should have a capacity of up to 45,000 N (10,117 lb).

5.4.1.3 Test Configuration

Frame-Level

The frame-level configuration shall be used for network equipment supplied with a framework.

Mount the equipment to its supporting framework.

Mount the equipment frame to the shaker table similar to how it will be installed in service. This may include using a concrete slab and anchors to simulate equipment installed on concrete building floors. In all cases use recommended fastener size, quantities, torque values, hold-down plates, shims, isolation devices, etc. Where concrete expansion anchors are normally used to fasten the framework base to the building floor, the mounting to shaker table may be substituted by welded studs, bolts, or cap-screws of equal quantities and diameter as the concrete expansion anchors.

The equipment shall be fastened to the shaker table (or concrete slab) using typical anchor locations. If the framework base allows for a variety of anchor locations, locate one fastener in the inner most location.

Record the torque value of each anchor or fastener.

Frames intended to support overhead cable shall be loaded with a weight of 23 kg (50.0 lb) on top of the framework. Less weight may be used if it can be demonstrated that the above value is excessive. Where less weight is used, the computations for such weight shall be provided as part of the test plan.

Frame-Level Instrumentation Configuration

Locate the accelerometers so they record the following: acceleration of the shaker table, acceleration at the top of the framework, and acceleration at the mid-height level.

Install anchor load measurement equipment to record the peak anchor loads if the concrete slab and concrete expansion anchors are omitted from the frame-level test.

Install deflection measurement equipment to measure the deflection at the top of the framework relative to its base.

Shelf-Level

The shelf-level configuration shall be used for network equipment supplied as a single shelf to be installed in framework by the purchaser.

Mount the shelf in a framework of the type that will be used in actual service.

[Table 5-3](#) provides guidelines for equipment installation.

Table 5-3 Configuration Guidelines for Shelf-Level Testing

Shelf Mass (kg)	Shelf Location for Testing	Overhead Cable Mass for Testing (kg)	Additional Rack Weights
$m < 23$	Top of Rack*	23	Per Note 1
$23 \leq m < 68$	Top of Rack*	23	Per Note 1
$68 \leq m < 181$	Center of Rack	0	None
$m \geq 181$	Lowest Position or Highest Recommended by Manufacturer	0	None

* Populate rack from the top down. If multiple test samples are fitted, test severity is sufficient in the upper 20% of the rack mounting height to provide adequate testing.

NOTE 1 - To simulate the weight and stiffness of a full framework, additional weight should be added to the framework. The specimen plus the additional weight should not exceed approximately 80% of the maximum load capacity of the framework. The additional weight added should be evenly distributed in the remainder of the framework in up to 4 locations. The weight should be attached to the framework using no more than 6 fasteners per weight per framework upright and shall not unduly stiffen the framework. Where the manufacturer anticipates several shelves to be installed to a frame, additional weight or shelves, as specified by the manufacturer, shall be added to simulate the load.

Mount the frame to the shaker table similar to how it will be installed in service. In all cases use recommended fastener size, quantities, torque values, hold-down plates, shims, and isolation devices. Where concrete expansion anchors are normally used to fasten the framework base to the building floor, the mounting to shaker table may be substituted by welded studs, bolts or cap-screws of equal quantities and diameter as the concrete expansion anchors.

Shelf-Level Instrumentation Configuration

Locate the accelerometers so they record the following: acceleration of the shaker table, acceleration at the top of the framework, and acceleration at the mid-height level.

Install deflection measurement equipment to measure the deflection at the top of the framework relative to its base.

Wall-Mount

The wall-mount configuration shall be used for network equipment supplied as a chassis to be wall mounted by the purchaser. The following procedures are to be used when testing wall-mounted equipment.

Mount the chassis on a fixture with a minimum resonance of 35 Hz. Use the same chassis orientation, fastener size, and fastener quantity as would be used to mount the specimen on a wall in service. The wall material and fastener types need not be the same as used in service, as the intent is to put the earthquake motion directly into the specimen via the fixture.

The earthquake motion shall be applied to the specimen in 3 axes. (The swept sine survey of the waveform test procedure need not be performed.)

Wall-Mount Instrumentation Configuration

Monitor the vibration input to the specimen using the control accelerometer on the fixture at the test item mounting point. Perform the Response Spectrum Analysis on this accelerometer. Deflection measurements need not be made.

5.4.1.4 Static Test Procedure

Follow the procedure below applying a load in **both directions** of the front-to-back axis, and **both directions** of the side-to-side axis of the framework. (It is permissible to static test a different framework specimen than is used for dynamic testing.)

1. Photograph the framework.
2. Slowly (about 45 N/second {10 lb./sec.}) apply a horizontal load to the top of the framework.
3. Record the deflection and load as the load increases from 0 up to a load equal to or greater than the total weight of the equipped framework plus the overhead cable weight, for Zone 4 level testing. Zone 3 may use 0.6 of this load. Zones 1 and 2 may use 0.4 of this load.
4. Continue to record the deflection and load as the load is slowly removed.
5. Record observations of structural damage.
6. Photograph the unloaded framework.

5.4.1.5 Waveform Test Procedure

CAUTION: Minimum Safety Procedures During Earthquake Testing

Waveform testing presents several safety issues that must be controlled during testing:

1. Strict professional laboratory safety procedures shall be employed to minimize hazard and danger to persons in the test area.
2. Waveform testing may cause printed circuit cards, doors, or other hardware to dislodge and become airborne hazards.
3. Waveform testing may cause equipment to rock or otherwise topple.
4. Working personnel and observers should exercise caution during handling of the concrete test slab and equipment.
5. Personal safety during all test procedures shall be observed, including safe practices during post-test examination. Maintain a minimum distance of 3000 mm (118 in) during testing and use proper protective eye-wear, clothing, and safety shoes at all times.

Follow this procedure for vertical, front-to-back, and side-to-side axes:

1. Perform a swept sine survey with an acceleration amplitude of 0.2 g from 1 to 50 Hz at a sweep rate of 1.0 octave per minute. (Higher sweep rates are permitted to reduce equipment stress.)
2. Verify equipment functionality and physical condition.
3. Subject the equipment to the VERTEQII waveform. Verify the TRS meets or exceeds the RRS in the frequency range from 1.0 to 50 Hz. If the TRS is below the RRS at any point, use the last drive signal and table acceleration to update the transfer function. Apply it to the Telcordia waveform to generate a new drive signal, and retest the equipment. Repeat this step as necessary.

The TRS should not exceed the RRS by more than 30% in the frequency range of 1 to 7 Hz. A test may be invalid if an equipment failure occurs when the TRS exceeds the RRS by more than 30% in this frequency range.

4. Record the displacement and acceleration data during the shaking.
5. Thoroughly inspect the equipment and note all changes to its physical condition.
6. Record any reductions in anchor or fastener torques.
7. Reverify equipment functionality.

5.4.1.6 Test Report

A test report shall be prepared at the conclusion of testing. The test report shall include:

- A list of the tests performed, when performed, and who performed them
- Photographs and videotapes
- Deflection versus load graphs from the static pull tests, if applicable
- Descriptions of any changes to the equipment's physical condition
- Anchor or fastener torque data
- Peak fastener load data, where applicable
- Deflection versus time graphs for the top of the framework
- Functionality data
- Plotted graphs of the TRS as compared to the RRS
- Plotted graphs of the acceleration-time histories for all accelerometers
- Other details necessary to fully describe the test.

5.4.2 Office Vibration Test Procedure

The office vibration test is often performed in conjunction with the synthesized waveform test, since the test configuration requirements are the same. In the test, the effects of office vibration are simulated by a swept sine survey.

Test Procedure for All Frame-Mounted or Wall-Mounted Equipment:

1. Mount the equipment being tested.
2. Subject the equipment to a swept sine survey at an acceleration amplitude of 0.1 g from 5 to 100 Hz and back to 5 Hz at a rate of 0.1 octave/minute. The duration of this sweep is approximately 90 minutes.
3. Repeat the sweep for each of three (3) mutually perpendicular framework axes.

Alternative Test Procedure for Electronic Subassemblies Only:

When many tests are involved, the following test may be substituted to eliminate the duplication of large-scale tests. Instead of testing complete frames to determine subassembly responses, or to directly perform the subassembly test, the following method may be used. The test applies to shelves, circuits packs, and other electronic subassemblies. It is not considered a substitute for equipment that can be tested using the frame-mounted office vibration procedure, but may provide some indication of a subassembly's resistance to office vibrations, prior to frame-mounted testing.

1. Mount the equipment directly on the shaker.
2. Subject the equipment to a swept sine at a level of 1.0 g from 5.0 to 100 Hz and return with a sweep rate of 0.25 octaves/minute.
3. Repeat the test for each of the three (3) mutually perpendicular axes of the equipment.

5.4.3 Transportation Vibration—Packaged Equipment

The transportation vibration test method is taken from **ETSI EN 300 019-2-2**, *Equipment Engineering (EE); Environmental conditions and environmental tests for telecommunications equipment; Part 2-2: Specification of environmental tests; Transportation, Test Specification T2.3 - Public Transportation*. While higher frequencies may be encountered in some transport modes, testing is restricted to the high energy, low frequency contributions.

Perform the test once along each of three (3) mutually perpendicular axes of the equipment.

1. Mount the packaged equipment (resting on its normal shipping base or side) securely on the vibration machine.
2. Measure the input acceleration with a suitable transducer.
3. Subject the package to the prescribed random vibration per [Table 5-4](#). For palletized containers, where the normal attitude during transportation is specified, then the severity for the horizontal axes is reduced by a factor of 10.
4. Subject the package to the prescribed random vibration for 30 minutes in each test axis.
5. Inspect the equipment for physical damage and verify operation following the vibration testing.

Table 5-4 Transportation Vibration Test Severity

Frequency Range (Hz)	Test Severity PSD Level
5 - 20	0.01 g ² /Hz
20 - 200	-3 dB/octave

NOTE: Equipment tested and found conforming using a composite profile that combines the Assurance Level 1 profiles for Truck, Rail, and Air of **ASTM 4169-04a** (*Practice for Performance Testing of Shipping Containers and Systems*), Section 12.4, also conform to the transportation vibration criterion of this document, **GR-63-CORE**.

Figure 5-19 Transportation Vibration Environment

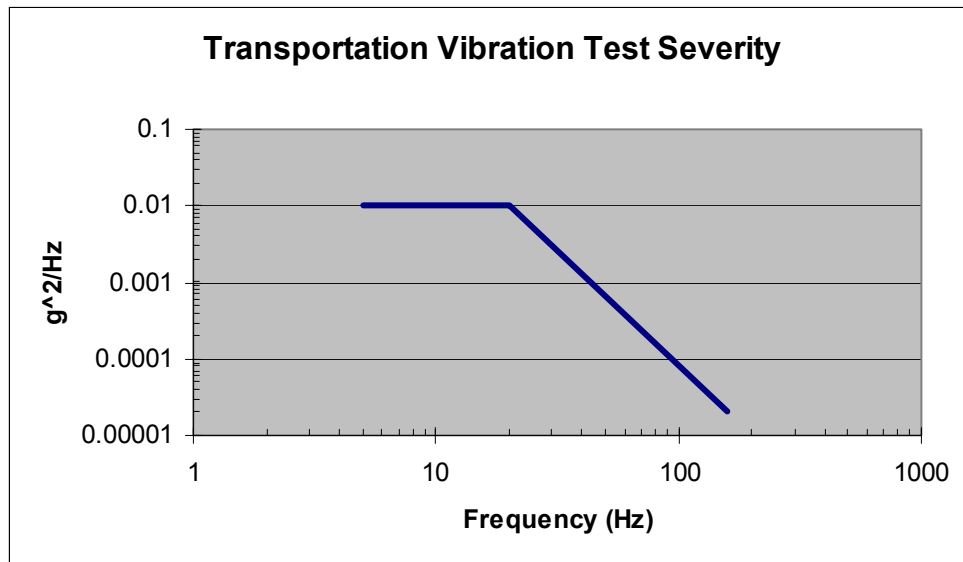

5.5 Airborne Contaminants Test Methods

5.5.1 Scope

This section provides test methods to determine whether telecommunications equipment can withstand the gaseous environmental contaminants and hygroscopic dust levels stated in [Section 4.5, “Airborne Contaminants.”](#) It applies to full shelf assemblies and subassemblies plus backplanes associated with both and can be extended to circuit packs (boards). Products tested are intended to be installed in equipment systems used in indoor or outdoor environments.

For boards with connectors, if it can be demonstrated that the connectors associated with the equipment under test were previously qualified at the system (per **GR-63-CORE**) or connector (per **GR-1217-CORE**, *Generic Requirements for Separable Electrical Connectors Used in Telecommunications Hardware*) level under the same or harsher conditions currently being implemented, then the connectors may be protected during the MFG testing.

It should be noted that fan-cooled equipment has the potential to corrode quicker. Preventative steps should be taken to ensure that fan-cooled equipment does not affect other equipment under testing. It is highly recommended to test only “similar” equipment (e.g., mechanically cooled equipment or natural convected equipment). If equipment is mixed with respect to the presence of fans, it must be demonstrated that the gas concentrations throughout the chamber meet the requirements set forth in this specification.

5.5.2 Gaseous Contaminants Test Method

Precisely-defined CO indoor and outdoor environmental conditions are difficult to achieve; a wide range of atmospheric variables are the rule because of seasonal, geographical, natural, and human influences. Indoor variations can be greater or less than the outdoor values depending on local sources, air-handling facilities, building construction, and the pollutant in question.

Accelerated atmospheric corrosion testing is an integral part of determining a component/system’s resistance to gaseous attack and subsequent degradation. Accelerated Atmospheric Corrosion Chambers (AACCs) are widely used for various types of atmospheric corrosion testing. For the past 10 years, Mixed Flowing Gas (MFG) corrosion chambers with concentration and control verification of all pollutant gases have been employed. The chosen test atmosphere constituents and their values are weighted approximations to natural phenomena (see [Section 4.5](#)).

The flow rate through the chamber should be adjusted so that the difference between the gas inlet and gas outlet concentrations are within the specified tolerance. Depending on the loading factor, chamber size and fan operation, the air exchange rate can range from 5 to 50 ACH. After placement of sample to be tested and the gases have been introduced, the equilibrium of the chamber should occur in several hours.

The MFG test is performed in a chamber made of a nonreactive, low-absorbing material. The chamber should be capable of maintaining temperature and relative humidity to the designated set points. A sample access port is suggested for easy placement and removal of control coupons. Using the sample port eliminates the need to shut off the gas supply during this process. However, for larger chambers it may be necessary to shut the gases off to place and remove copper coupons if access ports are not part of the chamber. The gas supply system must have the following:

- A source of clean, dry, filtered air
- A humidity source
- Corrosive gas source(s)
- Gas delivery system
- Corrosive gas concentration monitoring system.

The MFG procedure consists of the following steps (Steps 1 through 8) and each step must be addressed:

1) Chamber Calibration

- The test chamber shall be calibrated empty (without equipment in place) once a year, using either indoor or outdoor conditions, and a record shall be maintained.
- Refer to **ASTM B827-97** (*Standard Practice for Conducting Mixed Flowing Gas [MFG] Environmental Tests*); and **ASTM B810-01a** (*Test Method for Calibration of Atmospheric Corrosion Test Chambers by Change in Mass of Copper Coupons*) for using copper coupons during calibration.
- See [Section 5.5.2.1](#) for coupon preparation.
- Each gas monitoring analyzer should have, at least, one maintenance call or calibration per year.
- Temperature and RH sensors should be calibrated, at a minimum, once a year.
- Mass flow controllers should be checked periodically and tested for air flow.
- There are numerous ways to design and build an MFG chamber. See **ASTM B827-97** for more details.

2) Sample Preparation

- If the sample being tested uses forced-air cooling for its normal operation, the sample's internal fans must be on for the duration of the MFG test.
- For the MFG exposure, the fans shall be wired such that an external power supply of similar voltage provides power to the fans. No other sample components shall be powered during the MFG exposure.
- If the connectors have previously been qualified at the same or harsher conditions, they may be covered to prevent exposure.
- ESD (electrostatic discharge) preventative measures should be taken when handling sensitive equipment (i.e., wrist straps, use of ESD protective bags).

- Measures should be taken to prevent condensation on the equipment being placed in the chamber. Equipment under testing should be at a temperature greater than the temperature of the chamber prior to placement and start of test.
- The minimum test chamber size shall be determined by the size of the sample being tested. The inside dimensions of the test chamber shall have the following minimum clearances between the chamber wall and the test samples: 80 mm (3 in) on each side, 80 mm (3 in) front and back, and 100 mm (4 in) on the top and bottom. These clearances are required to ensure that the gas stream stabilizes before impinging the test samples. This assumes vertical gas flow; for horizontal gas flow chambers, the top/bottom and side/front/back dimensions should be interchanged. For larger test samples, the chamber should be designed accordingly.

3) Chamber Set-Up (without EUT)

- Clean humidity sensor.
- Introduce only Cl₂ into the chamber.
- Adjust the Cl₂ gas supply rate to obtain the specified target concentration listed in Table 5-6, “Target Air Composition and Duration of MFG Testing for Equipment Designated for Indoor or Outdoor Use,” (± 15% or 3 ppb, whichever is larger) and adjust the volume exchange rate until a delta of no more than the 15% or 3 ppb, whichever is larger, is obtained between the inlet and outlet gas concentrations.
- Record the concentration of Cl₂ at the inlet and outlet.
- Check the zero and span gas for Cl₂.
- Turn on the NO₂, SO₂ and H₂S gases.
- Adjust the NO₂, SO₂ and H₂S gas supply rates to obtain the specified target concentration listed in Table 5-6 (± 15% or 3 ppb, whichever is larger) and adjust the volume exchange rate until a delta of no more than the 15% or 3 ppb, whichever is larger, is obtained between the inlet and outlet gas concentrations.
- Record the concentrations of NO₂, SO₂ and H₂S at the inlet and outlet.
- Check the zero and span gas for NO₂, SO₂ and H₂S.
- Turn off all 4 gases.
- Wait until the chamber is free of any gases.

4) Chamber Set-Up (with EUT)

- Place equipment and coupons in chamber.
- Introduce only Cl₂ into the chamber.
- Adjust the Cl₂ gas supply rate to obtain the specified target concentration listed in Table 5-6 (± 15% or 3 ppb, whichever is larger) and adjust the volume exchange rate until a delta of no more than the 15% or 3 ppb, whichever is larger, is obtained between the inlet and outlet gas concentrations.

- Record the concentration of Cl₂ at the inlet and outlet.
- Turn on the NO₂, SO₂ and H₂S gases.
- Adjust the NO₂, SO₂ and H₂S gas supply rates to obtain the specified target concentration listed in [Table 5-6](#) ($\pm 15\%$ or 3 ppb, whichever is larger) and adjust the volume exchange rate until a delta of no more than the 15% or 3 ppb, whichever is larger, is obtained between the inlet and outlet gas concentrations.
- Record the concentrations of NO₂, SO₂ and H₂S at the inlet and outlet.
- Begin the testing cycle for 10 days.

5) Chamber Operation During Testing Interval

- Maintain humidity levels.
- Clean humidity sensor at the beginning of the test and after 5 days when the coupons are removed/replaced.
- Monitor the concentrations of the NO₂, SO₂ and H₂S gases at the inlet and outlet. A delta of a specified tolerance or less between the gas inlet and outlet is required for each gas. If needed, adjust the air exchange rate to maintain this delta of the specified tolerance.
- Remove coupons after 5 days and record weight gain in $\mu\text{g}/\text{cm}^2$ day.
- Typical weight gains are found in [Table 5-5, "Typical Coupon Weight Gains During MFG Exposures."](#)
- Place clean, unexposed coupons on the 5th day in the identical positions as the previous set of coupons.
- Maintain chamber in a non-illuminated condition.

6) Chamber Shut-Down (with EUT)

- Record the concentrations of NO₂, SO₂ and H₂S at the inlet and outlet.
- Record zero and span for NO₂, SO₂ and H₂S.
- Turn off the following gases: NO₂, SO₂ and H₂S.
- Record the zero, span and concentrations at the inlet and outlet for Cl₂.
- Turn off Cl₂ gas.
- Remove equipment and coupons.

7) Report

- See [Section 5.5.2.6, "Test Report."](#)

8) Copper Coupons

- It is a test requirement that the air flow and pollutant concentration throughout the MFG-AACC be spatially uniform and reproducible during the test to achieve

consistent results. **ASTM B 810-01a**, *Standard Test Method for Calibration of Atmospheric Corrosion Test Chambers by Change in Mass of Copper Coupons*, describes the placement scheme for calibration samples in a test chamber larger than 0.5 meter (21.7 in) on a side.

- Coupons should be cleaned by either Method 1 or Method 2 listed below prior to placement in the chamber. Since the area of a coupon is used in calculating the weight gain/day, the dimensions of the coupon may vary. However, typically a coupon, if rectangular in size, should be approximately:
26 mm × 12.5 mm × 1 mm thick.
- Coupons should be placed in opposite upper and lower quadrants of the chamber, near the equipment under test, but not in the direct airflow from equipment cooling fans or gas supply lines. The coupons placed in the lower quadrant should be at least 25.4 cm (10 in) from the floor of the chamber.

5.5.2.1 Two Cleaning Procedures for Copper Coupons

- A. Mark each coupon with a numbering code using a stamp without ink or engraving tool.
- B. During the cleaning process handle all coupons with only tweezers.
- C. The copper coupons are placed separately in a clean dry glass vial of similar size to the coupons.

- **Method 1:**

1. Immerse a coupon or small group of coupons in a glass beaker containing hot (65-85°C) 2% aqueous solution of a mildly alkaline (pH 7.5-10) detergent. Place beaker in an ultrasonic cleaner for 5 to 10 minutes.
2. Remove each coupon from the solution above and rinse under warm running tap water for 5 - 15 seconds. Immediately go to the next step.
3. Place the coupon into a solution of 1 part concentrated hydrochloric acid and 3 parts deionized water; suspend coupon vertically for 2 minutes in this solution.
4. Without allowing the surface of the coupon to dry, place the coupon immediately in one of the following solutions: a) suspend coupon vertically in flowing deionized water for 15 ± 5 seconds, b) suspend coupon with agitation for 15 ± 5 seconds in one beaker of deionized water and then place immediately in a second beaker of fresh deionized water.
5. Without allowing the surface of the coupon to dry, place the coupon immediately in a beaker of methanol while suspending the coupon vertically for 30 to 60 seconds with agitation in the ultrasonic cleaner.
6. Remove the coupon from the methanol and immediately blow dry with pre-purified nitrogen or clean dry air.
7. Place the clean coupon in a glass vial and cap after 10 minutes.

• **Method 2:**

1. Immerse coupon in n-Hexane for 2 minutes. Allow to drip dry for 10 seconds.
2. Immerse coupon in Alphametals Lonco flux 3355-11 or equivalent material for 15 seconds. Allow to drip dry for 10 seconds.
3. Rinse the coupon twice with deionized water for 15 seconds.
4. Rinse the coupon in methanol for 15 seconds and then allow to dry.
5. After drying, place coupon into the glass vial, and leave uncapped for 10 minutes.
6. After drying process is completed place cap on vial.

Prior to and after exposure a weight measurement is taken. Wait at least 1 hour after the coupon cleaning to weigh the coupons. Then allow the coupons to acclimate to the temperature of the room containing the weighing apparatus. Each coupon should be weighed a minimum of three (3) times with a standard deviation of 0.01 µg among the three (3) weights. If the weighing differs more than 0.01 µg, the coupon weight measurements need to be repeated until stable weights are achieved. After weighing the coupons, place them on holding fixtures and record the date and time of placement in the chamber. Remove coupons at the appropriate interval and allow the coupon to equilibrate for, at least, 30 minutes before re-weighing.

Calculate the weight difference before and after the exposure to the corrosion test.

Chamber Corrosivity Monitoring

Verification for accurate corrosivity of the test samples shall be done by using the copper coupon technique described in **ASTM B 810-01a**, and achieving the weight gains listed in **Table 5-5** during two 5-day exposure periods. The copper coupon weight gain can fluctuate depending on the type and amount of equipment in the chamber. If there is less equipment in the chamber, usually higher weight gains are noted. The coupons should be placed in opposite upper and lower quadrants of the chamber, and near the equipment under test, but not in the direct airflow from equipment cooling fans or gas supply lines. The coupons placed in the lower quadrant should be at least 25.4 cm (10 in) from the floor of the chamber. A minimum of 4 copper coupons should be placed in the chamber.

Table 5-5 Typical Coupon Weight Gains During MFG Exposures

Material	Range of Coupon Weight Gain (µg/cm ² /day)	
	Indoor	Outdoor
Copper	10-14	31-41

NOTE: Control coupons shall be un-lubricated and cleaned according to **ASTM B 810-01a** (see Section 5.5.2.1).

Chamber Exchange Rate

MFG exposures can be performed in chambers with either high or low exchange rates. High exchange rate chambers (operating at greater than 30 ACH) have the capability to expose larger and more equipment; however, it is important to remember that at higher air exchange rates, it can be more difficult to maintain the specified concentrations. Low air exchange rates usually operate between 5 and 15 air changes/hour. Although it is easier to maintain the specified concentrations of the pollutants gases, if the chamber is small and operating with a low air exchange it may be difficult to maintain the proper temperature.

The exchange rates for both high and low are the sum of new air and recirculated air that passes through the working section of the chamber. The exchange rate may consist of 100% new air and shall not include more than two-thirds recirculated air. This air flow is independent of any internal fan cooling air flow in the sample being tested. In all cases the chamber corrosivity requirements shall meet the results in [Table 5-5, “Typical Coupon Weight Gains During MFG Exposures,”](#) or be reported as a deviation.

It may be necessary to adjust the air exchange rates to obtain the specified tolerance between the gas inlet and outlet concentrations.

Overloading the chamber is an important factor to consider when exceeding the specified tolerance delta between the gas inlet and outlet.

The corrosivity shall be maintained within the bounds given by the test specification. Deviations from the expected corrosivity require immediate attention to controlling test parameters such as temperature, humidity, and gas concentration, to rectify the deviation. Inability to attain the specified corrosivity at the specified test-sample loading with all other parameters in the specified range shall be reported as a deviation in the test.

5.5.2.2 Test Procedure

The test shall be conducted as described in detail in **ASTM B-827-97**. The test protocol consists of the following major procedures: sample preparation and mounting, chamber start-up, chamber operation during test duration, chamber shutdown, and sample monitoring requirements. For either outdoor or indoor conditions, the testing will take place for 10 days. During this 10-day interval the chamber will only be open for the placement and removal of coupons. The chamber shall be shut down (gases off) prior to removal and placement of equipment.

The test duration and atmosphere shall be as [Table 5-6](#) describes. The outdoor test conditions shall be used for equipment that is normally placed outdoors.

Table 5-6 Target Air Composition and Duration of MFG Testing for Equipment Designated for Indoor or Outdoor Use

Normal Equipment Operating Location	Atmosphere	Test Duration
Indoor (Environmentally Controlled)	30°C, 70% R.H., 10 ppb Cl ₂ , 10 ppb H ₂ S, 200 ppb NO ₂ , 100 ppb SO ₂ Balance — air	10 days
Outdoor (Non-environmentally Controlled)	30°C, 70% R.H., 20 ppb Cl ₂ , 100 ppb H ₂ S, 200 ppb NO ₂ , 200 ppb SO ₂ Balance — air	10 days

NOTE 1: The inlet pollutant gas concentrations with respect to the target concentrations listed in [Table 5-6](#) should be within 15% or 3 ppb, whichever is larger.

NOTE 2: The inlet-to-outlet pollutant gas concentrations should be less than 15% or 3 ppb, whichever is larger.

5.5.2.3 Measuring Parameters

The test chamber shall be monitored to verify that the following conditions are met:

1. The temperature is 30°C ± 1.0°C.
2. The humidity is 70% RH ± 3% RH.
3. The temperature and humidity shall be monitored constantly.
4. Monitoring instruments must be calibrated, at least once a year, because the corrosive effects of mixed gas environments can affect instrument sensitivity and accuracy.
5. The pollutant gas concentrations are measured at the gas inlet and gas outlet and should be within a specified tolerance. This can be achieved by adjusting the air exchange rate or reducing the load in the chamber.
6. All four gases (NO₂, SO₂, H₂S, and Cl₂) shall be introduced into the chamber at the same time during an exposure period.
7. To verify accuracy of corrosion rates, the coupon weight gains shown in [Table 5-5](#), “Typical Coupon Weight Gains During MFG Exposures,” should be achieved when monitoring equipment in a corrosion chamber.
8. **ASTM B 810-01a** shall be used to calibrate all test chambers. [Table 5-5](#) shall also be used to verify accuracy of the chamber’s corrosion during calibration.
9. The test will consist of 10 sampling days with only the removal and placement of coupons to be conducted during this period.

10. The chamber should be shut down (gases off) prior to removal or placement of equipment.
11. Equipment under test should be tested for functionality pre- and post-exposure of the MFG test.
12. It is strongly advisable to test fan-cooled and non-fan cooled equipment separately.

5.5.2.4 Safety Procedures for Testing Gaseous Contaminants

Gaseous contaminants testing uses gases of varying toxicity. Those personnel performing the test must be aware of potential hazards, and the proper methods for handling the gases and operating the test equipment.

1. Procedures for safe handling of the gas containers, and information on the potential health hazards should be obtained from the gas supplier.
2. Federal and state OSHA safety procedures for handling toxic gases within the laboratory shall be followed.

5.5.2.5 Performance Criteria

All test samples shall be operated before and after environmental testing, and will be required to meet their applicable functionality requirements. Any deviation from normal operation shall be considered a failure of the MFG testing.

The criteria for assessing functionality depend on the service provided by the equipment being tested. The criteria are determined by applying appropriate Telcordia generic requirements, or, if none exists, by the supplier's or purchaser's own performance specifications.

ESD (electrostatic discharge) preventative measures should be taken when handling sensitive equipment (i.e., wrist straps, use of ESD protective bags).

5.5.2.6 Test Report

A report shall be prepared that contains the following information:

1. Date of testing interval
2. Test samples — Description, number of test samples, condition tested, exposure intervals, data summary
3. Copper Coupons—Description, placement, duration of sampling interval and procedure used for preparation and analysis (see [Section 5.5.2.1, “Two Cleaning Procedures for Copper Coupons,”](#)) plus recorded weight gain measurements.
4. Gas concentrations, temperature and humidity, air velocity, direction, illumination condition, air exchange rate, and test method
5. Chamber dimensions
6. Usable chamber working space

7. Deviation from normal test conditions
8. All interruptions (reasons and duration).

A sample test report format is shown in [Figure 5-20](#) (Sheets 1 and 2).

Figure 5-20 Sample Test Report (Sheet 1 of 2)

GR-63-CORE NEBS Requirements: Physical Protection Environmental Test Methods
Gaseous Contaminants (Mixed Flowing Gas)

TEST REPORT

Test Condition: Indoor Outdoor

Test Laboratory:

Customer Name/Address:	
Report Prepared By:	
Report Preparation Date:	
Test Interval Dates:	
Test Samples: Include sample description and number of test samples.	
Data Summary and Test Results:	

Test Set-up:

Test Chamber Dimensions:	
Test Chamber Working Space:	
Air Changes per hour:	
Copper Coupon Cleaning Method Used:	
Fanned cooled with fans operating during testing	YES NO

Test Data:

Gas Concentrations (ppb)				
	Cl ₂	NO ₂	SO ₂	H ₂ S
Initial Concentrations				
Without EUT				
Inlet				
Outlet				
Inlet to Outlet delta (%)				
With EUT				
Inlet				
Outlet				
Inlet to Outlet delta (%)				
Final Concentrations				
With EUT				
Inlet				
Outlet				
Inlet to Outlet delta (%)				
During duration of test				
Minimum Conc.	N/A			
Maximum Conc.	N/A			
Average delta	N/A			
Maintained 15% or less delta during testing	N/A	Yes No	Yes No	Yes No

Figure 5-20 Sample Test Report (Sheet 2 of 2)

Coupon Weight Gain				
	Upper	Upper	Lower	Lower
Days 1-5 Weight Gain (ug/cm ² day)				
Days 6-10 Weight Gain (ug/cm ² day)				

Chamber Conditions			
	Average	Maximum	Minimum
Relative Humidity			
Temperature			

Description and Explanation of any test anomalies, interruptions (reason and duration), and deviation from required test conditions:

Schematic Diagram of test chamber with air flow, coupon placement, and placement of test samples indicated. Show placement of test samples relative to any other products in the chamber. Example for illustrative purposes only. Provide diagram that reflects the design of chamber where testing occurred.

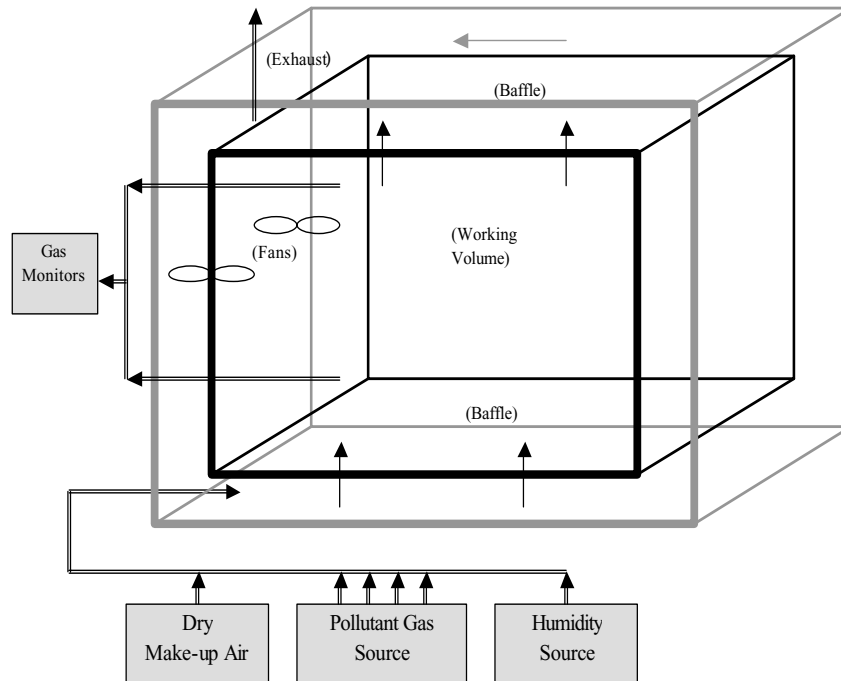

5.5.3 Hygroscopic Dust Test Method

It is the view of Telcordia that the testing of powered circuit packs or subassemblies is sufficient to predict the system performance of equipment assemblies that are exposed to the airborne particulate contaminant levels listed in [Table 4-11, “Outdoor Contaminant Levels,”](#) and [Table 4-12, “Indoor Contaminant Levels,”](#) of [Section 4.5.2](#). Such a test method is described in detail in **GR-1274-CORE**, *Generic Requirements for Reliability Qualification Testing of Printed Wiring Assemblies Exposed to Airborne Hygroscopic Dust*. This test method shall be used to determine equipment conformance relative to the criteria of [Section 4.5.2, “Contamination Levels.”](#)

Rather than duplicate the variable type of dust that actually contaminates telecommunications circuit boards, the test method of **GR-1274-CORE** simulates the electrical effects of fine mode particle dust by reducing surface insulation resistance.

5.5.3.1 Sample Selection

Samples of each printed wiring board shall be tested unless it can be shown that samples within a design family are representative of the entire design family. In this case, only different samples within the design family representing the worst-case criteria for the design family need to be tested.

NOTE: For example, a sample representing the worst-case criteria would be a sample that contains the smallest conductor spacings for a particular electric field between the conductors.

A design family consists of printed wiring boards from the same board manufacturer; using the same materials, the same design rules for minimum line spacing for a maximum electric field, and using components that require the same bias voltages. Within the same family, boards shall have the same finish, i.e., they shall all be bare or all be coated with the same overcoat. The test samples shall be of different functional types within the same family where possible.

5.5.3.2 Test Sequence

The test consists of three (3) phases with the first phase recommended, but optional. If the first phase is omitted, it will be assumed no failure was observed during phase 1. In phase 1, the printed wiring boards shall be tested for functional performance and dynamic characteristics in their host system, prior to contamination when exposed to a 12-hour soak at 40% RH then a 4-hour ramp to 85% RH with a final soak at 85% RH for 24 hours. If the system has already passed the high humidity test described in [Section 5.1.2](#), the first phase can be omitted. The second phase of the test consists of coating the printed wiring boards with a surface film (e.g., single component hygroscopic solution) that will lower their surface insulation resistance at high humidity. The circuit board connectors shall be protected during the coating. The third and last phase requires re-inserting the boards in their host systems and testing them for functional performance and dynamic characteristics when exposed to high humidity which will lower the surface insulation resistance.

The test sequence detailed in **GR-1274-CORE** consists of the following:

1. Testing the selected printed wiring assemblies to a 12-hour soak at 40% RH then a 4-hour ramp to 85% RH with a final soak at 85% RH for 24 hours (this step may be by-passed if high humidity testing as described in [Section 5.1.2](#) was already performed).
2. Determining the threshold relative humidity (RHt) at which the surface insulation resistance on the Institute for Interconnecting and Packaging Electronic Circuits (IPC-B-25) coupons is equal to $1 \times 10^6 \Omega$.
3. Calibrating the surface film deposition for uniformity on IPC coupons. The insulation resistance of the coupons used for uniformity control shall be between 5×10^5 and $5 \times 10^6 \Omega$ at RHt.
4. Coating the selected printed wiring assemblies.
5. Mounting the printed wiring assemblies in their host system.
6. The RHt (see item #2 above for the definition of RHt) should be between 70% and 85% RH. Testing the contaminated printed wiring assemblies through two ramps of relative humidity from 40% to RHt with a 2-hour soak at 40% and RHt.
7. A minimum of 5 (five) data points shall be collected during an increase in relative humidity of 10% (percentage) points.

5.5.3.3 Performance Criteria

A printed wiring assembly or a design family shall be considered to have passed the test if all tested samples remain functional after contamination when the relative humidity is cycled between 40% and RHt. If a printed wiring assembly, whether tested alone or as part of a design family, fails after contamination and if the failure is related to surface leakage current, the printed wiring assembly or the represented design family, as applicable, will be considered to have failed the hygroscopic dust test.

5.5.3.4 Test Report

The test report shall contain the following:

1. Date and location of test
2. Description of design family (minimum line spacing, maximum electric field, minimum lead separation, bare/solder mask/conformal coating, materials, etc.) and test samples.
3. Test conditions (surface film composition and deposition technique, surface density, temperature and humidity (RHt) during test, test duration, resistance versus relative humidity characteristic obtained on the IPC coupon)
4. Deviations from normal conditions
5. All interruptions (reasons and duration)
6. Performance results with failure analysis, if applicable.

5.6 Acoustical Measurement Methodology

The sound power level shall be determined in full conformance with the measurement methods specified in:

- **ANSI S12.10-2002 ISO 7779:1999**, *NAIS Standard Acoustics - Measurement of airborne noise emitted by information technology and telecommunications equipment*,
- **ANSI S12.12-1992 (R2002)**, *American National Standard Engineering Method for the Determination of Sound Power Levels of Noise Sources using Sound Intensity*, or
- **ANSI S12.54-1999 ISO 3744:1994 (R2004)**, *American National Standard Acoustics - Determination of sound power levels of noise sources using sound pressure - Engineering method in an essentially free field over a reflecting plane*.

The installation and operating conditions specified in **ANSI S12.10** shall be used unless they differ from those specified herein, in which case those defined in this document shall be used.

The equipment under test shall be installed and operated according to its intended use, in a representative configuration (e.g., a “typical” or “principal” configuration of equipment shelves in a telecommunications rack). This configuration shall be adequately described in all test reports and noise declarations resulting from these measurements.

For equipment whose noise levels vary with temperature (e.g., for equipment with speed-controlled air moving devices), the sound power level shall be measured according to either [Section 5.6.1](#) or [Section 5.6.2](#) and optionally [Section 5.6.3](#) for normal operating conditions, and shall be measured according to [Section 5.6.4](#) for high-temperature operating conditions. For equipment whose noise levels do not vary with temperature, measurements need only be made according to [Section 5.6.3](#), which is consistent with the above-mentioned measurement standards.

5.6.1 Procedure for Nominal, 27°C (81°F) Operating Conditions: Test Room at 27°C (81°F)

The ambient temperature in the test environment shall be set to the noise emission limit requirement temperature of $27^{\circ}\text{C} \pm 1^{\circ}\text{C}$, and acoustical measurements taken in accordance with the standards. Consideration for normal test room temperature variation shall be taken into account when making measurements and care should be taken to ensure that all variable-speed air moving devices maintain a consistent speed during the course of the acoustical measurements. A method for monitoring the air-moving device speeds during the measurements is recommended.

5.6.2 Procedure for Nominal, 27°C (81°F) Operating Conditions: Test Room at Other Than 27°C (81°F)

For this method, the ambient temperature in the test environment shall be set as appropriate, but the air-moving devices within the equipment under test shall be set to the speed that the devices would run at if the equipment were operating in an ambient temperature equal to 27°C (81°F). A method for monitoring the air-moving device speeds during the measurements is recommended.

5.6.3 Procedure for Nominal, 23°C (73°F) Operating Conditions

The ambient temperature in the test environment shall be set to 23°C (73°F) and the acoustical measurements taken in accordance with the standards.

5.6.4 Procedure for High-Temperature Operating Conditions

NOTE: There is no specified noise emission limit for this high-temperature condition.

In order to characterize the maximum (“worst-case”) noise-emission levels, the ambient temperature in the test environment shall set as appropriate, but the air-moving devices within the equipment under test shall be set to the highest speed settings they would run at in any environment. The data shall be recorded and the results provided in a test report.

5.7 Lighting Test Methods

This section presents test methods for determining whether equipment and lighting systems comply with the requirements in [Section 4.7, “Illumination.”](#) The methods cover equipment assemblies, consoles, and lighting systems. Test 1 analyzes the readability, glare, and surface reflectance of equipment. Test 2 analyzes the illumination, readability, and glare effects on consoles, either with or without integral luminaires. Test 3 analyzes the adequacy of lighting systems used to illuminate various network facility areas, including equipment and distributing frames, power, cable entrance, and maintenance areas.

In each of the test methods, the following operations or precautions should be followed:

1. Fluorescent bulbs and lamp fixtures shall be in good working order. Bulbs which appear to be dim or flickering shall be replaced with new bulbs.
2. Daylight should be excluded during the test. Avoid wearing bright clothing or casting shadows on the light meters.
3. Use a light meter that is color- and cosine-corrected. The intensity should have an accuracy of $\pm 15\%$ of the indicated reading for these tests. (The color- and cosine-correction is a characteristic of the light meter diode sensor and lens/filter and these characteristics do not require calibration.)

- Reference luminaires to be used in Tests 1 and 2 should be typical ceiling supported fixtures that house one or more twin-tube, U-shaped, or other efficient fluorescent lamps, each of which has a cool-white or comparable color temperature rated no more than 40W. These reference luminaires, lighted alone, should pass Test 3, per [Section 5.7.3](#). An adequate light radiation pattern should exist, with a minimum maintained illumination of 75 lux (*7 footcandles*) over the least illuminated areas, usually at the base of equipment frames.

5.7.1 Test 1 - Equipment Assembly - Readability, Glare, and Reflectance Tests

Test Procedure - Equipment Assembly Readability and Glare:

- Locate two (2) reference luminaires relative to Position A of the equipment frame as [Figure 5-21](#) shows.
- Position the frame-mounted equipment units as shown. Analyze the equipment units at their lowest expected position in the frame.
- An observer with 20-20 natural or corrected vision (not color blind) should be positioned so that the line-of-sight distance to the specific material to be read is about 457 mm (*18 in*). From this position, the observer should read words, letters, numbers, etc., on the equipment unit.
- The observer should analyze readability by assessing how easily and accurately he/she can read from that position.
- The observer should rate the glare (either direct or reflected) as either none, slight, annoying, or impairing readability.
- Change the configuration so that the two (2) reference luminaires are located relative to Position B of the equipment frames as [Figure 5-21](#) shows.
- The observer should again evaluate the readability and glare as described in Steps 3 through 5.
- Rotate the equipment specimen, or reposition the referenced luminaires, and repeat Steps 1 through 7 for all sides of the equipment that may be accessed during maintenance.
- For assessment of rear surfaces, supplemental lighting, such as a hand-held flash light may be used. If so, report in the test results that supplemental lighting was used for rear surfaces.
- If an equipment frame or enclosure affects conformance of an equipment shelf mounted within it, the shelf may be removed from the frame or enclosure and given a stand-alone assessment. Report such test results separately, identifying that these are for stand-alone testing.

Test Procedure - Equipment Surface Reflectance:

- Position two (2) reference luminaires as [Figure 5-22](#) shows.
- Position the frame-mounted equipment units at their normal height in the frame, as shown.

3. Position a white blotter with an assumed reflectance of 75% or other known standard {100 mm × 250 mm (*4 × 10 in*), minimum size} against the surface of the unit to be measured, as [Figure 5-22](#) shows.
4. With the card against the test surface, hold the light meter 50-75 mm (*2-3 in*) away from the center of the blotter. Record the reflected light reading.
5. Remove the card and measure the light reflected from the test surface with the meter in about the same position.
6. Calculate the reflectance (R) as follows:

$$R = \text{Card Reflectance} \times \frac{\text{Meter reading with card removed}}{\text{Meter reading with card in place}}$$

7. Rotate the equipment specimen, or reposition the referenced luminaires, and repeat Steps 1 through 6 for all sides of the equipment that may be accessed during maintenance.

Figure 5-21 Test 1 - Equipment Assembly, Readability, and Glare

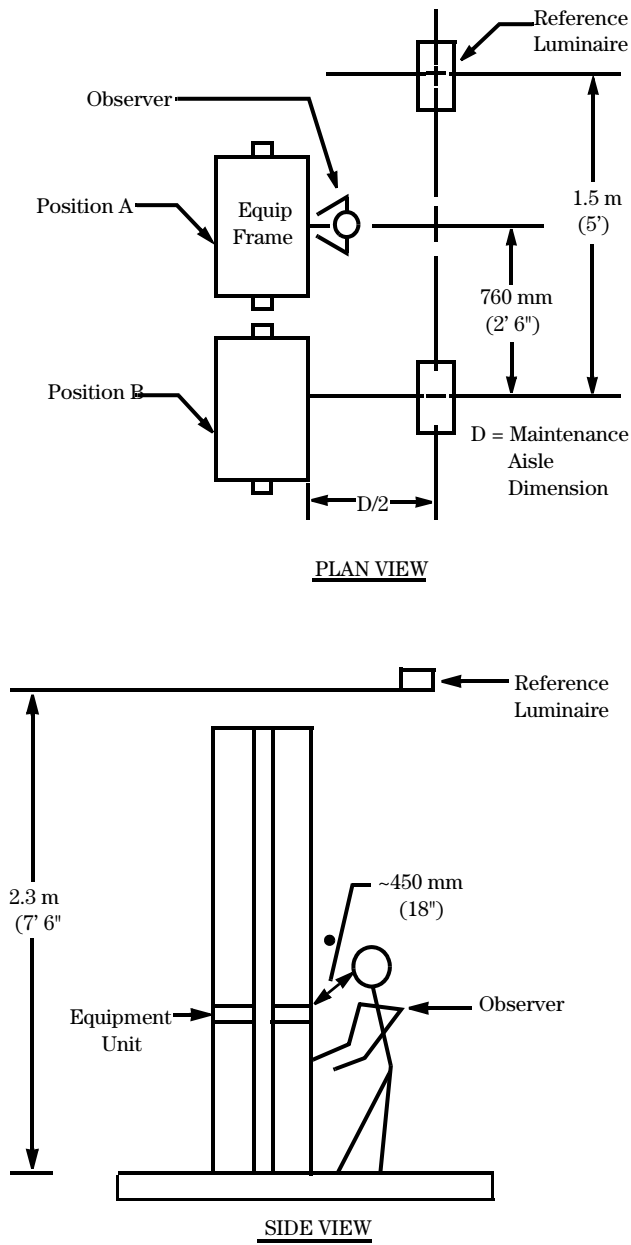
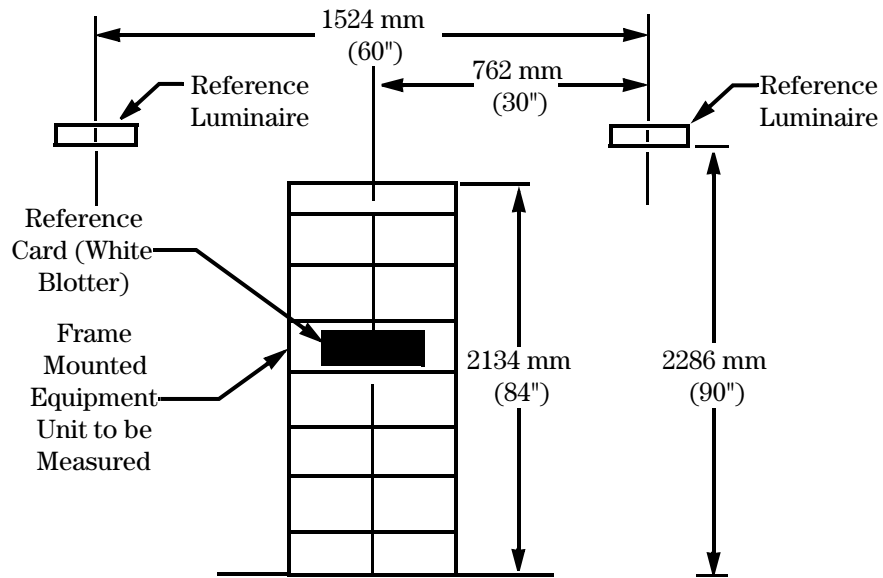
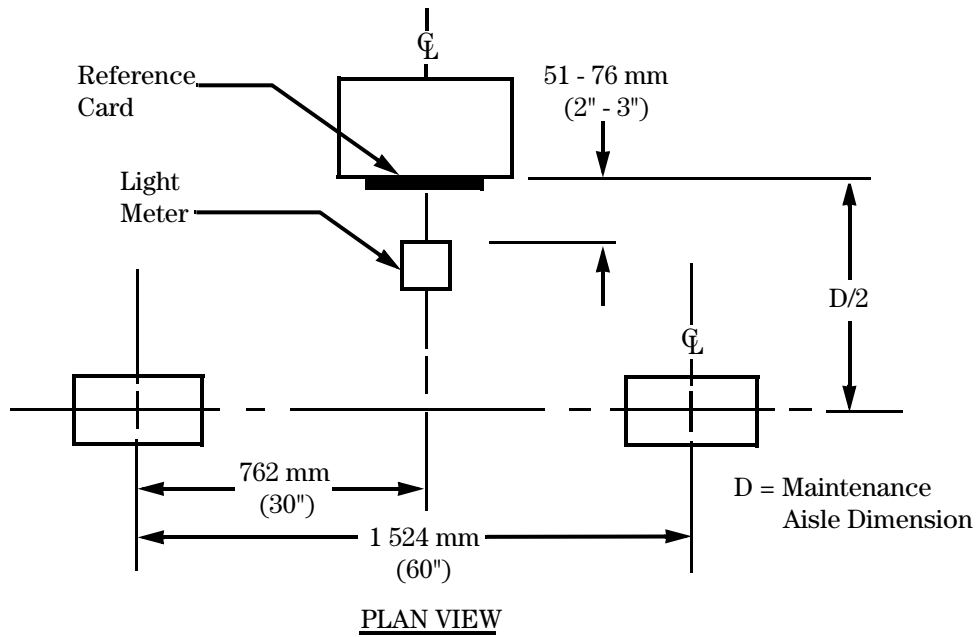

Figure 5-22 Test 1 - Equipment Assembly, Surface Reflectance



5.7.2 Test 2 - Console Illumination, Readability, and Glare Tests

Test Procedure - Consoles Without Integral Luminaires:

1. Illuminate each working surface of the console to at least the minimum levels stated in [Section 4.7](#).
2. Place a reference luminaire at Position A at the 3-m level (*≈10-foot*) (see [Figure 5-23](#)). It may be necessary either to partially shield the luminaire or to use additional luminaires at point A to obtain the minimum level.
3. The observer, seated normally, should read words, letters, numbers, etc., on the console. (The observer should have 20-20 natural or corrected vision.)
4. The observer should evaluate the readability by assessing how easily and accurately he/she can read from that position.
5. The observer should rate the glare (either direct or reflected) as either none, annoying, or impairing readability.
6. Repeat the above procedure (Steps 1 through 4) for luminaire Positions B through I (see [Figure 5-23](#)).

Test Procedure - Consoles With Integral Luminaires:

1. With only the integral luminaire lighted, read the illumination in footcandles on all console surfaces where visual tasks are to be performed. The light-sensitive surface of the meter should be parallel to the surface being measured and in a position to measure the incident light. The lowest reading should exceed the incident light and the minimum illumination levels specified in [Section 4.7](#) for control, test, and maintenance areas.
2. With only the integral luminaire lighted, analyze readability and glare (as described in Steps 2 through 4 in the procedure above).
3. Place a single reference luminaire at Position A at the 3-m level (*≈10-foot*) (see [Figure 5-23](#)).
4. With both the integral and the reference luminaire A lighted, perform illumination tests as described in Step 1 of the procedure above.
5. With both the integral and reference luminaire A lighted, perform a readability test and glare analysis (as described in Steps 2 through 3 in the procedure above).
6. Repeat Steps 3 through 5 of the procedure above with the integral luminaire lighted for each position of the reference luminaire (Positions B through I on [Figure 5-23](#)).

Figure 5-23 Console Illumination, Readability, and Glare

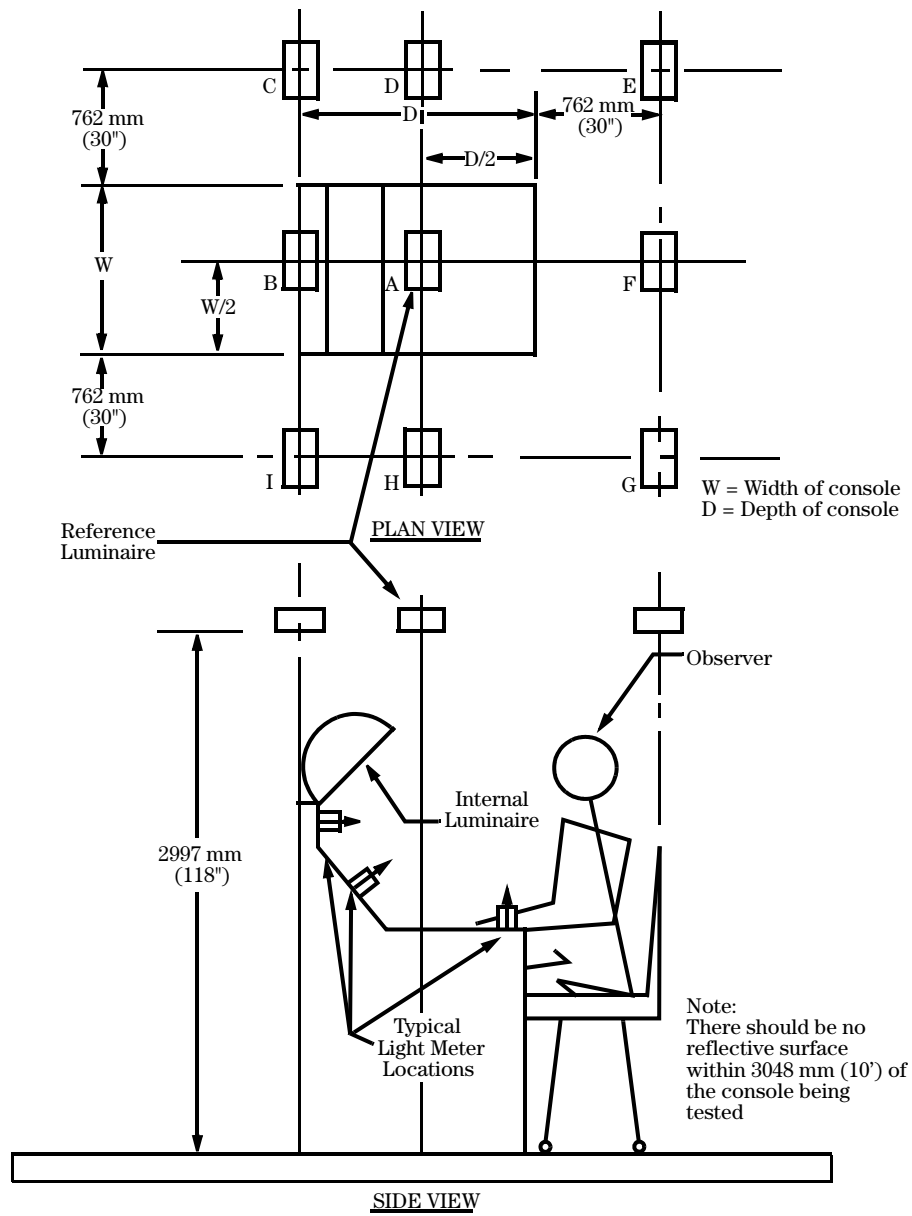

5.7.3 Test 3 - Lighting System Tests

Test 1 should be used to analyze the readability, glare, etc., of equipment assemblies in equipment frames and distributing frames. The following test is used to determine the adequacy of lighting systems used in these areas.

Test Procedure:

1. Position the luminaires at nominal height and spacing as [Figure 5-24](#) or [Figure 5-25](#) shows.
2. Position the light meter as [Figure 5-24](#) or [Figure 5-25](#) shows.
3. Aim the light meter upward and read the illumination, in lux, at points A, B, and C. The lowest reading should exceed the minimum illumination levels specified in [Section 4.7, "Illumination."](#)

The adequacy of lighting systems to illuminate control, test, and maintenance areas shown should be analyzed according to procedures outlined for Console Tests (Test 2). The illumination levels should exceed the values specified in [Section 4.7](#).

Figure 5-24 Lighting System Test 3, Equipment Distribution Frame Areas

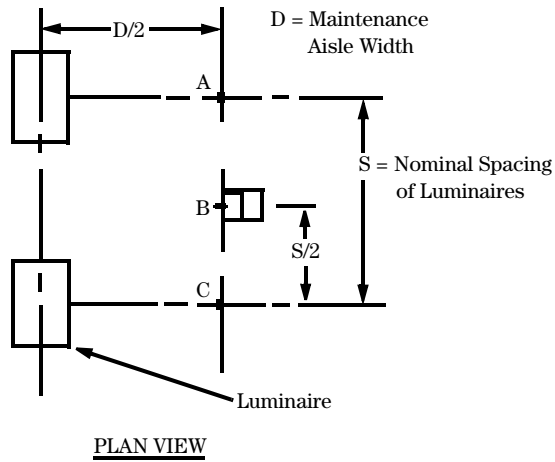
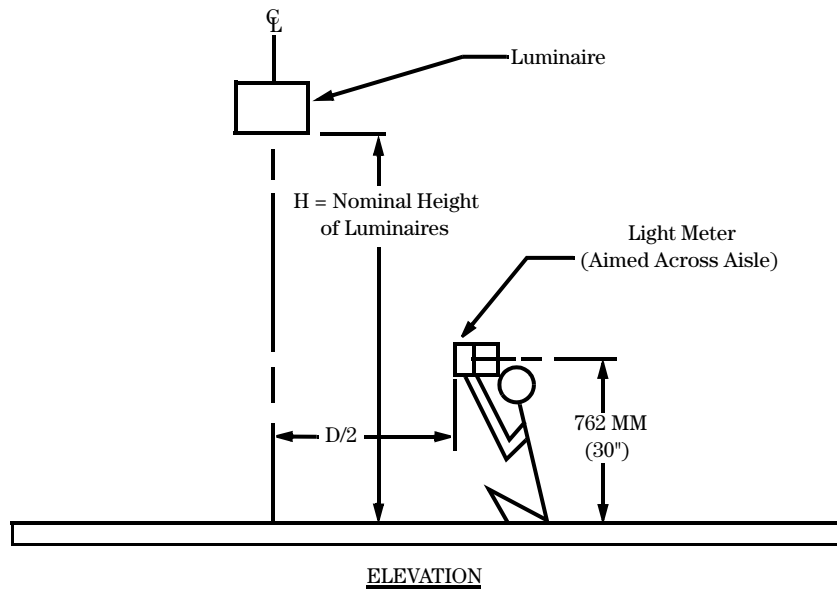
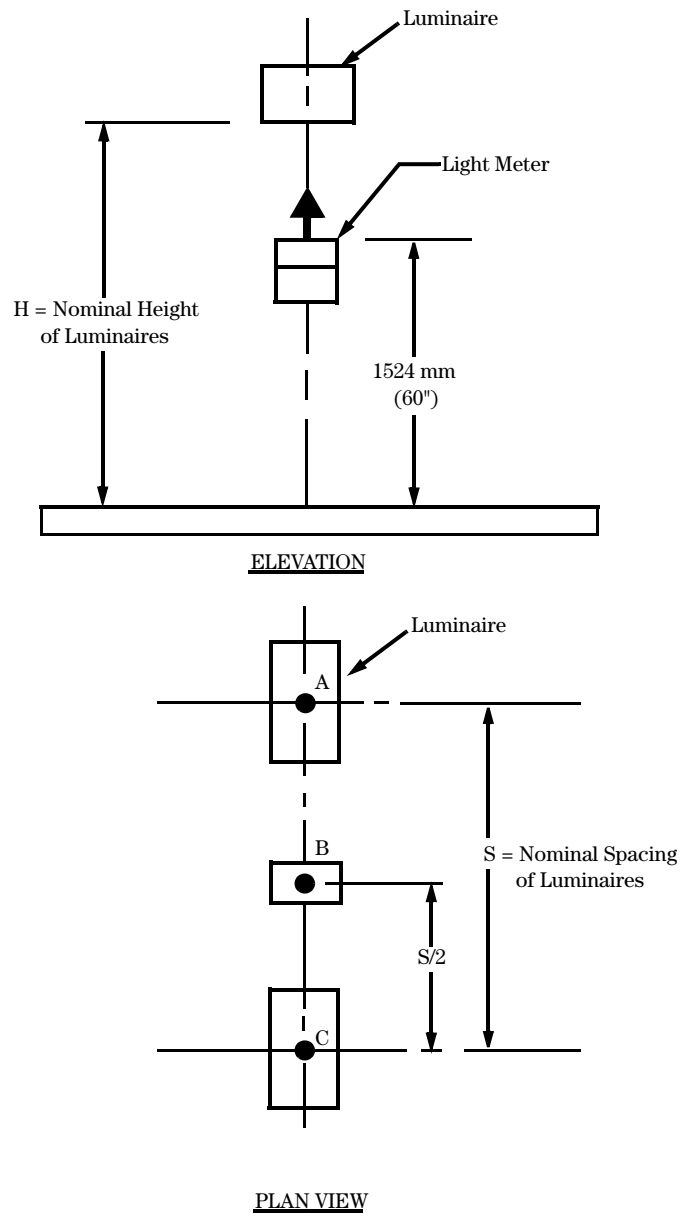

Figure 5-25 Lighting System Test 3, Power and Cable Entrance Areas





Appendix A: References

A.1 Telcordia Documents

- **GR-78-CORE**, *Generic Requirements for the Physical Design and Manufacture of Telecommunications Products and Equipment* (a module of RQGR, FR-796).
- **GR-209-CORE**, *Generic Requirements for Product Change Notices (PCNs)*.
- **GR-295-CORE**, *Mesh and Isolated Bonding Networks: Definition and Application to Telephone Central Offices*.
- **GR-357-CORE**, *Generic Requirements for Assuring the Reliability of Components Used in Telecommunication Equipment* (a module of RQGR, FR-796).
- **GR-1089-CORE**, *Electromagnetic Compatibility and Electrical Safety - Generic Criteria for Network Telecommunications Equipment* (a module of LSSGR, FR-64; TSGR, FR-440; and NEBSFR, FR-2063).
- **GR-1217-CORE**, *Generic Requirements for Separable Electrical Connectors Used in Telecommunications Hardware*.
- **GR-1274-CORE**, *Generic Requirements for Reliability Qualification Testing of Printed Wiring Assemblies Exposed to Airborne Hygroscopic Dust*.
- **GR-3028-CORE**, *Thermal Management in Telecommunication Central Offices: Thermal GR-3028*.
- **GR-3108-CORE**, *Generic Requirements for Network Equipment in the Outside Plant (OSP)*.
- **SR-3580**, *NEBS™ Criteria Levels*.

Telcordia Document Sets

- **FR-64**, *LATA Switching Systems Generic Requirements (LSSGR)*.
- **FR-440**, *Transport Systems Generic Requirements (TSGR)*.
- **FR-796**, *Reliability and Quality Generic Requirements (RQGR)*.
- **FR-2063**, *Network Equipment-Building System NEBS™ Family of Requirements (NEBSFR)*.
- **FR-INSTALL-19**, *Central Office Environment Installation Requirements and Services*.

A.2 Other Referenced Documents or Material

- **ANSI/IEEE 1202-1991**, *Flame testing of cables for use in cable tray in industrial and commercial occupancies.*
- **ANSI/NFPA 262-2002**, *Test for fire and smoke characteristics of wires and cables.*
- **ANSI/NFPA 70-2002**, *National electrical code.*
- **ANSI S12.10-2002 ISO 7779:1999**, *NAIS Standard Acoustics - Measurement of airborne noise emitted by information technology and telecommunications equipment.*
- **ANSI S12.12-1992 (R2002)**, *American National Standard Engineering Method for the Determination of Sound Power Levels of Noise Sources using Sound Intensity.*
- **ANSI S12.54-1999 ISO 3744:1994 (R2004)**, *American National Standard Acoustics - Determination of sound power levels of noise sources using sound pressure - Engineering method in an essentially free field over a reflecting plane.*
- **ANSI T1.307-2003**, *Fire-Resistance Criteria - Ignitability Requirements for Equipment Assemblies, Ancillary Non-Metallic Apparatus, and Fire Spread Requirements for Wire and Cable.*
- **ANSI T1.319-2002**, *Equipment Assemblies - Fire Propagation Risk Assessment Criteria.*
- **ANSI T1.336-2003**, *Engineering Requirements for a Universal Telecom Framework.*
- **ANSI/UL 94-1996**, *Test for flammability of plastic materials for parts in devices and appliances.*
- **ANSI/UL 1441-1995**, *Coated Electrical Sleeving.*
- **ANSI/UL 1581-2001**, *Reference standard for electrical wires, cables, and flexible cords.*
- **ANSI/UL 1666-2000**, *Test for flame propagation height of electrical and optical-fiber cables installed vertically in shafts.*
- **ASHRAE Standard 52.1**, *Gravimetric and Dust-Spot Procedures for Testing Air Cleaning Devices Used in General Ventilation for Removing Particulate Matter*, 1992.
- **ASHRAE Standard 52.2**, *Method of Testing General Ventilation Air Cleaning Devices for Removal Efficiency by Particle Size*, 1999.
- **ASTM B810-01a**, *Test Method for Calibration of Atmospheric Corrosion Test Chambers by Change in Mass of Copper Coupons.*
- **ASTM B827-97-2003**, *Standard Practice for Conducting Mixed Flowing Gas (MFG) Environmental Tests.*

- **ASTM D2863-00**, *Standard Test Method for Measuring the Minimum Oxygen Concentration to Support Candle-Like Combustion of Plastics (Oxygen Index)*.
- **ASTM 4169-04**, *Practice for Performance Testing of Shipping Containers and Systems*.
- **ASTM D6216-03**, *Practice for Opacity Monitor Manufacturers to Certify Conformance with Design and Performance Specifications*.
- **ATIS-060004**, *Equipment Surface Temperature*.
- **ATIS-0600005**, *Acoustic Measurement*.
- **CAN/CS-C22.2 No. 0.3-01**, *Test methods for electrical wires and cables*.
- **EIA-310-D**, *Cabinets, Racks, Panels, and Associated Equipment*.
- **ETSI EN 300 019-2-2**, *Equipment Engineering (EE); Environmental conditions and environmental test for telecommunications equipment; Part 2-2: Specification of environmental tests; Transportation, Test Specification T2.3 - Public Transportation*.
- **Part 1910**, *Occupational Safety and Health Standards (Title 29 - Labor, Chapter XVII-OSHA, Department of Labor)*.
- **UL 900**, *Standard Air Filter Units*, 1994.
- **UL 510-2005**, *Insulating Tape*.
- **UL 60950**, *Safety of Information Technology Equipment*.
- **UL 1685-1997**, *Vertical-tray fire-propagation and smoke-release test for electrical and optical-fiber cable*.
- **UL 2024A-2002**, *Outline of Investigation for Optical Fiber Cable Routing Assemblies*.

To Obtain Additional Reference Material

Alliance for Telecommunications Industry Solutions (ATIS)	http://www.atis.org/
American National Standards Institute (ANSI)	http://web.ansi.org/
American Society of Heating, Refrigerating and Air-Conditioning Engineers, Inc. (ASHRAE)	http://www.ashrae.org/
American Society for Testing and Materials (ASTM)	http://www.astm.com/
Canadian Standards Association (CSA)	http://www.csa.ca/
Electronic Code of Federal Regulations (e-CFR)	http://ecfr.gpoaccess.gov/
Electronic Industries Alliance (EIA)	http://www.eia.org/
European Telecommunications Standards Institute (ETSI)	http://www.etsi.org/
Institute of Electrical and Electronics Engineers (IEEE)	http://ieee.org/
International Electrotechnical Commission (IEC)	http://www.iec.ch/
International Organization for Standardization (ISO)	http://www.iso.org/
National Fire Protection Association (NFPA)	http://www.nfpa.org/
Underwriters Laboratories (UL)	http://www.ul.com/

Note

All Telcordia documents are subject to change, and their citations in this document reflect the most current information available at the time of this printing. Readers are advised to check current status and availability of all documents.

To Contact Telcordia Customer Service or to Order Documents

Telcordia Customer Service
One Telcordia Drive, Room 1B-180
Piscataway, NJ 08854-4182
1.866.672.6997 (USA)
+ 1.732.699.6700 (Worldwide)
+ 1.732.336.2226 (FAX)
e-mail: document-info@telcordia.com
web site: <http://telecom-info.telcordia.com>

To Order Documents Online From the Telcordia Information SuperStore

1. **Go to the SuperStore Web site:** <http://telecom-info.telcordia.com>
(At this site, the **Search** and **Browse** selections provide access to the Telcordia catalog of technical information.)
2. If you know the document number, enter it in the **Search** box in the left margin and click **Go!**
3. Click on the desired product match.

If you do not know the document number, do the following:

1. Click on **Search** located on the top bar.
2. In the **Keywords field**, enter the keywords (or document number), then click **Submit Search**.
3. Click on the desired product match.

To Order Documents From Within Telcordia (Employees Only)

1. Access the Telcordia Internal Home Page (InSite).
2. Click on **Self-Service** on the Navigation Bar.
3. Click on **Document Database**.
4. Click on **Basic Search** in the bullet list to obtain the Basic Search Criteria box.
5. In the Search by Document Number field, enter the document number (e.g., GR-454), then scroll down to click on **Submit Search**.
6. In the Basic Search Navigation List, select **Click for Abstract** to order an available document, or select **Click for Document** to view an available document.

For New Information on Telcordia Technologies Technical Products

- **Digest** (*Free Download or E-mail Distribution List*)

Telcordia offers an electronic-only monthly publication — the *Digest of Technical Information*, which provides the latest information on GRs and other products. At the *Digest* Web site, you may view recent document releases and download the monthly *Digest* PDF files at no charge. For more information visit:

<http://www.telcordia.com/digest>

- **Digest Plus** (Free Subscription)

Telcordia also offers a printed publication — the *Digest Plus*, which includes a quarterly compilation of new document releases and other items that appeared in the monthly issues of the *Digest*. For more information visit:

<http://telecom-info.telcordia.com> (Click on Digest on the top.)

Appendix B: Acronyms

AACC — Accelerated Atmospheric Corrosion Chamber	FCC — Federal Communications Commission
ANSI — American National Standards Institute	FDF — Fiber Distributing Frame
ASHRAE — American Society of Heating, Refrigerating and Air-Conditioning Engineers, Inc.	FFT — Fast Fourier Transform
ASTM — American Society for Testing and Materials	FLIIM — Frame Level Ignition Indicator Module
ATIS — Alliance for Telecommunications Industry Solutions	FR — Family of Requirements (Telcordia)
CCB — Circuit Concentration Bay	GC/MS — Gas Chromatographic/Mass Spectroscopic
CCS — Conventional Cooling System	GDF — Group Distributing Frame
CDS — Cable Distribution System	GR — Generic Requirements document (Telcordia)
CEF — Cable Entrance Facility	HVAC — Heating, Ventilating, and Air Conditioning
CEV — Controlled Environment Vault	IDF — Intermediate Distribution Frame
CMM — Corrositivity Monitor Materials	IEC — International Electrotechnical Commission
CO — Central Office <i>or</i> Currently Orderable	IEEE — Institute of Electrical and Electronics Engineers
CSA — Canadian Standards Association	IF — Interconnecting Frame
DC — Direct Current	ILR — Issues List Report
DF — Distributing Frame	IPC — Institute for Interconnecting and Packaging Electronic Circuits
DSX — Digital System Cross-Connect	ISO — International Organization for Standardization
EC — Equipment Cooling	LVDT — Linear Variable Displacement Transducer
e-CFR — Electronic Code of Federal Regulations	MCS — Modular Cooling System
EEE — Electronic Equipment Enclosures	MDF — Main Distributing Frame
EIA — Electronic Industries Alliance	MERV — Minimum Efficiency Rating Value
EMC — Electromagnetic Compatibility	MFG — Mixed Flowing Gas
EPA — Environmental Protection Agency	ND — NEBS Data
ESD — Electrostatic Discharge	NEC — National Electrical Code
ETSI — European Telecommunications Standards Institute	NESC — National Electrical Safety Code
EUT — Equipment Under Test	NFPA — National Fire Protection Association
EWFD — Early Warning Fire Detection	
FA — Framework Advisory	

NO — Not Orderable

NOM — Not Orderable, but usable for additions or maintenance purposes

OEM — Original Equipment Manufacturer

OS — Operations System

OSHA — Occupational Safety and Health Administration

OSP — Outside Plant

PCB — Printed Circuit Board

PCN — Product Change Notice

PF — Protector Frame

PWB — Printed Wiring Board

QCX — Quick Connect and Cross Connect

R — Reflectance

RCA — Root Cause Analysis

RH — Relative Humidity

RHt — threshold Relative Humidity

RRS — Required Response Spectrum

RT — Remote Terminal

RTD — Resistance Temperature Detector

SLIIM — Shelf Level Ignition Indicator Module

TA — Technical Advisory

TDF — Trunk Distributing Frame

TR — Technical Reference

TRS — Test Response Spectrum

TSP — Total Suspended Particulate

UL — Underwriters Laboratories

Requirement-Object Index

[1] ... R2-1	Page 2-1	[69] .. R4-3	Page 4-2	[113] . O4-71	Page 4-24
[2] ... R2-2	Page 2-1	[70] .. R4-5	Page 4-3	[114] . R4-72	Page 4-24
[3] ... R2-3	Page 2-1	[71] .. R4-4	Page 4-2	[115] . O4-73	Page 4-24
[4] ... O2-4	Page 2-1	[72] .. R4-6	Page 4-3	[116] . O4-74	Page 4-24
[5] ... R2-5	Page 2-1	[73] .. R4-7	Page 4-5	[117] . R4-75	Page 4-24
[6] ... R2-6	Page 2-1	[74] .. R4-8	Page 4-5	[118] . O4-76	Page 4-25
[7] ... O2-7	Page 2-2	[75] .. R4-10	Page 4-5	[119] . R4-77	Page 4-25
[8] ... O2-8	Page 2-2	[76] .. O4-12	Page 4-5	[120] . O4-78	Page 4-25
[9] ... O2-9	Page 2-3	[77] .. R4-19	Page 4-6	[121] . O4-79	Page 4-25
[10] .. O2-12	Page 2-3	[78] .. O4-20	Page 4-7	[122] . R4-81	Page 4-26
[11] .. O2-13	Page 2-3	[79] .. O4-21	Page 4-8	[123] . R4-82	Page 4-26
[12] .. R2-14	Page 2-3	[80] .. R4-25	Page 4-12	[124] . R4-83	Page 4-27
[13] .. O2-15	Page 2-8	[81] .. R4-26	Page 4-12	[125] . R4-84	Page 4-29
[14] .. O2-16	Page 2-9	[82] .. R4-28	Page 4-13	[126] . O4-85	Page 4-29
[15] .. R2-22	Page 2-11	[83] .. O4-29	Page 4-13	[127] . R4-86	Page 4-31
[16] .. O2-23	Page 2-12	[84] .. O4-30	Page 4-13	[128] . R4-96	Page 4-34
[17] .. R2-24	Page 2-12	[85] .. R4-31	Page 4-13	[129] . R4-98	Page 4-35
[18] .. O2-25	Page 2-12	[86] .. R4-32	Page 4-13	[130] . O4-99	Page 4-35
[19] .. R2-26	Page 2-12	[87] .. R4-34	Page 4-14	[131] . R4-100	Page 4-36
[20] .. R2-27	Page 2-14	[88] .. O4-35	Page 4-14	[132] . O4-103	Page 4-37
[21] .. R2-28	Page 2-14	[89] .. O4-36	Page 4-14	[133] . O4-104	Page 4-37
[22] .. O2-29	Page 2-14	[90] .. R4-42	Page 4-15	[134] . O4-101	Page 4-37
[23] .. R2-30	Page 2-14	[91] .. R4-43	Page 4-15	[135] . O4-102	Page 4-37
[24] .. O2-31	Page 2-15	[92] .. R4-44	Page 4-15	[136] . R4-9	Page 4-5
[25] .. R2-32	Page 2-16	[93] .. R4-45	Page 4-16	[137] . O4-11	Page 4-5
[26] .. R2-33	Page 2-17	[94] .. R4-46	Page 4-16	[138] . R4-87	Page 4-32
[27] .. O2-34	Page 2-17	[95] .. R4-47	Page 4-16	[139] . R4-88	Page 4-32
[28] .. O2-35	Page 2-17	[96] .. R4-48	Page 4-16	[140] . R4-90	Page 4-33
[29] .. O2-36	Page 2-18	[97] .. R4-49	Page 4-16	[141] . R4-91	Page 4-33
[30] .. O2-37	Page 2-18	[98] .. R4-50	Page 4-16	[142] . R4-92	Page 4-33
[31] .. O2-38	Page 2-18	[99] .. O4-51	Page 4-16	[143] . R4-93	Page 4-33
[32] .. O2-39	Page 2-18	[100] . R4-52	Page 4-17	[144] . O4-94	Page 4-33
[33] .. O2-40	Page 2-18	[101] . R4-53	Page 4-17	[145] . O4-95	Page 4-33
[34] .. R2-41	Page 2-18	[102] . R4-54	Page 4-17	[146] . R2-10	Page 2-3
[35] .. R2-42	Page 2-18	[103] . R4-55	Page 4-17	[147] . R2-11	Page 2-3
[36] .. O2-43	Page 2-19	[104] . O4-56	Page 4-18	[148] . O2-17	Page 2-9
[37] .. O2-44	Page 2-21	[105] . R4-57	Page 4-18	[149] . O2-18	Page 2-9
[38] .. R2-45	Page 2-22	[106] . O4-58	Page 4-18	[150] . O2-19	Page 2-10
[39] .. O2-46	Page 2-23	[107] . R4-65	Page 4-20	[151] . R2-20	Page 2-11
[40] .. O2-47	Page 2-23	[108] . R4-66	Page 4-20	[152] . O2-21	Page 2-11
[41] .. R2-48	Page 2-23	[109] . R4-67	Page 4-21	[153] . R4-13	Page 4-5
[42] .. R2-49	Page 2-23	[110] . R4-68	Page 4-23	[154] . R4-14	Page 4-6
[67] .. R4-1	Page 4-1	[111] . R4-69	Page 4-24	[155] . R4-15	Page 4-6
[68] .. R4-2	Page 4-1	[112] . R4-70	Page 4-24	[156] . O4-16	Page 4-6

[157] . R4-17 Page 4-6
[158] . R4-18 Page 4-6
[159] . R4-22 Page 4-8
[160] . O4-23 Page 4-10
[161] . O4-24 Page 4-10
[162] . R4-27 Page 4-12
[163] . R4-33 Page 4-13
[164] . O4-37 Page 4-14
[165] . O4-38 Page 4-14
[166] . R4-39 Page 4-14
[167] . O4-40 Page 4-14
[168] . R4-41 Page 4-14
[169] . R4-59 Page 4-18
[170] . R4-60 Page 4-18
[171] . R4-61 Page 4-18
[172] . R4-62 Page 4-19
[173] . R4-63 Page 4-19
[174] . R4-64 Page 4-19
[175] . R4-80 Page 4-26
[176] . R4-89 Page 4-33
[177] . R4-97 Page 4-35



TELCORDIA ENTERPRISE LICENSE AGREEMENT AND LIMITED WARRANTY

For Technical Documents: Generic Requirements (GRs), Special Reports (SRs), Technical References (TRs), Technical Advisories (TAs), Family of Requirements (FRs), Family of Documents (FDs), Framework Advisories (FAs), Science Technologies (STs), Message Driven Program (MDPs), Information Publications (IPs), Audio Visuals (AVs) and Telcordia Practices (BRs)

IMPORTANT! READ CAREFULLY

USE OF THIS PRODUCT INDICATES THAT YOU (LICENSEE OR USER) HAVE READ AND ACCEPT THE TERMS OF THIS AGREEMENT. IF YOU DO NOT AGREE WITH THE TERMS OF THIS AGREEMENT, PROMPTLY RETURN THE UNUSED PRODUCT WITH ALL SEALS INTACT TO THE ADDRESS LISTED BELOW FOR A TELCORDIA CREDIT.

1. LICENSE GRANT

Telcordia grants to customer ("Licensee") a non-exclusive, non-transferable, limited license to use this Licensed Product by employees of Licensee ("Users") for internal business purposes only. All intellectual property rights, title and interest in all Licensed Products furnished to Licensee remain in Telcordia. This License does not preclude the execution of additional license agreements with Licensee for the Licensed Product(s).

Telcordia has exclusive rights to all Licensed Products which are protected by United States and international copyright laws.

2. LICENSEE'S USE:

a) Licensee may place the Licensed Products on a Local Area Network, Wide Area Network, server, internal web site, or other electronic computing platform shared or accessible to employees or affiliates of Licensee. Licensee may make paper and electronic copies of Licensed Products as determined by Licensee to be necessary for Licensee's internal purposes; provided all copies, in whole or in part, of the Licensed Products shall bear the same Telcordia copyright and disclaimer notices legend as appear on the Licensed Products originally furnished to Licensee by Telcordia.

b) Subject to the preceding paragraph, Licensee may reproduce and distribute Licensed Products to "Affiliates" defined as (i) the parent entity (corporation or partnership) which directly or indirectly owns the majority of the outstanding shares or interests of Licensee, (ii) a sibling entity (corporation or partnership) the majority of whose outstanding shares or interests are owned by its parent entity, or (iii) a subsidiary entity (corporation or partnership) the majority of whose outstanding shares or interests are owned by Licensee, provided, however, that such entity shall continue to remain an Affiliate hereunder only as long as the applicable ownership interest as described above exists.

Licensee may sublicense the rights granted in this section to an Affiliate, provided Licensee shall remain responsible for any breach by such Affiliate. Licensee shall ensure that such Affiliate as assignee agrees to be bound by the rights, obligations and limitations set forth herein, and such Affiliate shall be responsible for any breach by such Affiliate and Licensee shall ensure that Telcordia shall have the right of direct enforcement of such obligations against such Affiliate. If a direct enforcement claim is denied, for any reason, it is agreed that Licensor may assert such claim against Licensee.

c) Licensee may copy portions of Licensed Products to create specifications and related documentation (the "Licensee Documentation").

d) Licensee may, in marketing a product or related services (collectively, "Licensee Product"), (i) make reference to the Licensed Product utilized in the development of Licensee Product; provided that Licensee shall make no statement, representation or warranty on behalf of Telcordia including but not limited to a certification by Telcordia of a product's or related service's compliance with the Licensed Product, unless otherwise agreed to by the parties in writing; or (ii) distribute the

Licensee Documentation to a third party prior to sale of the Licensee Product.

e) Licensee may refer to and/or incorporate portions of such Licensed Products in the Licensee Documentation for the Licensee Product and copy the Licensee Documentation for distribution in conjunction with the sale of the Licensee Product to any third party so long as the original Telcordia and copyright legends, as applicable, are acknowledged on the specifications and/or documentation.

f) Licensee must treat the Licensed Product(s) like any other copyrighted material.

g) Except as otherwise stated, it is understood that the foregoing license does not include the right to make copies of the Licensed Products for sale to third parties or to create derivative works for sale.

USER MAY NOT:

a) Copy the Licensed Product, except as provided above;

b) Make copies of the Licensed Product or portions thereof as are permitted above for internal purposes that contain provisions that conflict or differ in content from comparable provisions of the Licensed Product, unless such differences are identified specifically, and it is made clear in such copies that the results are not part of the Licensed Product;

c) Transfer the Licensed Product to another party, except as provided above;

d) Licensee may not make the Licensed Product available, in whole or in part for the purposes of external distribution to third parties other than Affiliates.

e) Grant sublicenses, leases, or other rights to the Licensed Product or rent the Licensed Products to others, except as provided above; or

f) Make telecommunications data transmissions of the Licensed Product to the public or any third party.

g) Data, in whole or in part, may not be extracted from the Licensed Product(s) for use in any derivative Licensee product or used to verify and subsequently modify data in any Licensee product which is sold, licensed or otherwise provided to third parties unless Licensee has executed a separately negotiated Special License Agreement with Telcordia, except as provided above.

3. AUDITS

Upon reasonable written notice to Licensee, Telcordia shall have the right to review Licensee's compliance with the terms and conditions of this License Agreement ("Agreement"). If such review reveals a violation of the requirements set forth herein, in addition to any other remedies it may have, Telcordia may terminate this Agreement in accordance with the Termination section of this Agreement.

4. FEES AND PAYMENTS

All fees and charges due hereunder shall be paid in full within thirty (30) days of the date of the invoice. Overdue payments are subject to a late payment charge, calculated and compounded monthly, and calculated at an annual rate of either (1) one percent (1%) over the prime rate available in New York City, as published in *The Wall Street Journal* on the first Monday (or the next bank business day) following the payment due date; or (2) 12 percent (12%), whichever shall be

higher. If the amount of the late payment charge exceeds the maximum permitted by law, the charge will be reduced to that maximum amount.

Licensee shall pay or reimburse Telcordia for all sales or use taxes, duties, or levies imposed by any authority, government or government agency (other than those levied on the net income of Telcordia) in connection with this Agreement. If Telcordia is required to collect a tax to be paid by Licensee, Licensee shall pay this tax on demand. If Licensee fails to pay these taxes, duties or levies, Licensee shall pay all reasonable expenses incurred by Telcordia, including reasonable attorney's fees, to collect such taxes, duties or levies.

Telcordia shall provide Licensee with one (1) Copy of the Licensed Product. Any additional copies in cd or paper media will be provided to Licensee at a cost of \$75.00 per copy. Please contact our Customer Call Center noted below.

5. LIMITED WARRANTY

Telcordia warrants that the media on which the Licensed Product is provided is free from defects in materials and workmanship for 90 days. Licensee's sole remedy for breach of this warranty is Telcordia's Product Replacement Plan described below. This warranty applies only to the original Licensee.

6. DISCLAIMER OF WARRANTIES

EXCEPT AS SET FORTH ABOVE, THE LICENSED PRODUCT IS PROVIDED "AS IS" WITHOUT WARRANTY OF ANY KIND, EITHER EXPRESS OR IMPLIED, INCLUDING, BUT NOT LIMITED TO THE IMPLIED WARRANTIES OF MERCHANTABILITY AND FITNESS FOR A PARTICULAR PURPOSE, EVEN IF TELCORDIA HAS BEEN MADE AWARE OF SUCH PURPOSE, OR ANY WARRANTY AGAINST INFRINGEMENT OF PATENTS OR OTHER INTELLECTUAL PROPERTY RIGHTS. LICENSEE ASSUMES RESPONSIBILITY FOR THE SELECTION OF THE LICENSED PRODUCT TO ACHIEVE ITS INTENDED RESULTS, AND FOR THE USE AND RESULTS OBTAINED FROM THE LICENSED PRODUCT.

7. LIMITATION OF LIABILITY

THE ENTIRE LIABILITY OF TELCORDIA, AND LICENSEE'S EXCLUSIVE REMEDY, IS THE REPLACEMENT OF ANY LICENSED PRODUCT WHICH DOES NOT MEET THE TELCORDIA LIMITED WARRANTY AND IS RETURNED TO TELCORDIA WITHIN 90 DAYS.

IN NO EVENT WILL TELCORDIA BE LIABLE TO LICENSEE FOR ANY DAMAGES, INCLUDING DIRECT DAMAGES, LOST PROFITS, OR OTHER INDIRECT, SPECIAL, INCIDENTAL, EXEMPLARY OR CONSEQUENTIAL DAMAGES ARISING OUT OF THIS AGREEMENT, EVEN IF TELCORDIA HAS BEEN ADVISED OF THE POSSIBILITY OF SUCH DAMAGES.

THE WARRANTY GIVES LICENSEE SPECIFIC LEGAL RIGHTS, AND LICENSEE MAY ALSO HAVE OTHER RIGHTS WHICH VARY FROM STATE TO STATE. SOME STATES DO NOT ALLOW THE EXCLUSION OR LIMITATION OF INCIDENTAL OR CONSEQUENTIAL DAMAGES, SO THE ABOVE LIMITATION MAY NOT APPLY TO LICENSEE.

8. THIRD PARTY PRODUCTS AND INFORMATION WARRANTY

Telcordia does not warrant Third Party products or information which Telcordia may use to prepare the Licensed Product. Third Party products or information may be warranted by Third Parties as expressly provided in the documentation accompanying the Third Party product or information, if any. Licensee's exclusive remedy under any Third Party warranty is as provided in the Third Party documentation accompanying the Third Party product or information, if any.

9. LICENSED PRODUCT REPLACEMENT PLAN

During the first 30 days after Licensee licenses the Telcordia Licensed Product, Telcordia will replace at no charge any Licensed Product which is returned to Telcordia because its media is defective in materials or workmanship. Returns for replacement of a defective Licensed Product should be sent postpaid to Telcordia using the Return Policy procedures stated below.

10. RETURN POLICY

Licensed Product(s) may be returned within 30 days of receipt for Telcordia credit only. Returned Licensed Products must be in their original packaging with all seals intact. Returns not found to be defective in materials or workmanship will be subject to a 10%

restocking fee. Licensed Products that have been delivered electronically (downloaded from the Superstore) are **not** eligible for credits, refunds or returns, even if duplicative with Licensed Products that are the subject of prior or contemporaneous orders. Licensee assumes all responsibility for managing its inventory of Licensed Product(s).

11. TERMINATION

If Licensee or its User breaches one or more of its obligations under this Agreement, Telcordia may elect at any time, in addition to any other remedy, to terminate the license and rights granted. Prior to the termination, Telcordia must give Licensee two (2) months written notice specifying the breach. Telcordia may terminate the license and rights granted if Licensee does not remedy all breaches specified in the written notice within the two (2) month notice period. Upon termination of the license and rights granted, Licensee shall destroy or return all Licensed Product(s) and Documentation, including all copies, and certify in writing to Telcordia the destruction or return.

12. PUBLICITY

Notwithstanding anything herein to the contrary, each party is prohibited from using in advertising, publicity, promotion, marketing, or other similar activity, any name, trade name, trademark, or other designation including any abbreviation, contraction or simulation of the other without the prior, express, written permission of the other.

13. GENERAL

Reexport. Licensee acknowledges that any commodities and/or technical data provided under this Agreement is subject to the Export Administration Regulations ("the EAR") administered by the U.S. Commerce Department and that any export or re-export thereof must be in compliance with the EAR. Licensee agrees that it shall not export or reexport, directly or indirectly, either during the term of this Agreement or after its expiration, any commodities and/or technical data (or direct products thereof) provided under this Agreement in any form to destinations in Country Groups D:1 or E:2, as specified in Supplement No. 1 to Part 740 of the EAR, and as modified from time to time by the U.S. Department of Commerce, or to recipients or destinations that are otherwise controlled or embargoed under U.S. law.

Foreign Tax Payment. For a Licensee which is not a United States corporation, Telcordia will not accept remittance of less than the full amount billed to Licensee as full payment unless:

- a) Licensee withholds that amount to satisfy tax withholding requirements imposed by the country (other than the United States) in which Licensee resides or in which Licensee has accepted delivery of the Licensed Product; and
- b) Licensee furnishes a receipt issued by the withholding tax jurisdiction and certifying deposit of the withheld amount into its treasury or other tax depository to Telcordia's sole credit, or a certification on Licensee's stationery that Licensee has deposited the withheld amount into its tax jurisdiction's treasury or other tax depository to Telcordia's sole credit.

Further, to ensure the orderly processing of Telcordia tax returns, Licensee shall provide to Telcordia a summary of all amounts withheld during the year no later than ten business days after December 31 of each year.

Governing Law. This Agreement is a contract between Telcordia and the Licensee of the Licensed Product. This contract is to be interpreted in the federal and state courts of New Jersey, in accordance with the laws of the State of New Jersey without regard to its conflict of laws principles, and the parties consent to the jurisdiction of such courts for this purpose.

Entire Agreement. Licensee further agree that this is the complete and exclusive statement of the Agreement between Licensee and Telcordia and supersedes any proposal or prior Agreement, oral or written, or any other communication between us relating to the subject matter of this Agreement.

All questions about this Agreement should be directed to:

Telcordia Technologies, Inc.
Customer Service Center
One Telcordia Drive, RRC 1B180
Piscataway, NJ 08854

Phone: 1.866.672.6997 (USA)
+1.732.699.6700 (Worldwide)

END OF TERMS AND CONDITIONS

Agreed:

Company: _____

—

Name: _____

Signature: _____

Date: _____

Revised 3/06